

SILVELOX
OPEN YOUR SPACE

SR SRV SLD SLS SP

INDICE

INDEX

- P.6** LE UNICITÀ E LE INNOVAZIONI
DELLE NOSTRE PORTE SEZIONALI PER GARAGE
UNIQUENESS AND INNOVATIONS OF OUR
SECTIONAL GARAGE DOORS
- P.10** PORTE SEZIONALI RESIDENZIALI PER GARAGE
RESIDENTIAL SECTIONAL GARAGE DOORS
- P.12** CATEGORIE ESTETICHE
PANNELLI SERIE SR-SRV-SLD-SLS
PANELS PATTERNS CATEGORIES
SR-SRV-SLD-SLS SERIES
- P.14** ESTETICA BIDOGA
DOUBLES LAT PATTERN
MODELLO / MODEL TOCANTINS
MODELLO / MODEL GOIAS
MODELLO / MODEL SAO PAULO
- P.18** ESTETICA PIANA
PLANAR PATTERN
MODELLO / MODEL RONDONIA
MODELLO / MODEL BAHIA
MODELLO / MODEL AMAZONAS
- P.22** ESTETICA MULTIDOGA
MULTISLAT PATTERN
MODELLO / MODEL SERGIPE
MODELLO / MODEL PARANÀ
MODELLO / MODEL AMAPÀ
MODELLO / MODEL BRASILIA
- P.28** ESTETICA VENEZIANA
VENETIAN PATTERN
MODELLO / MODEL PARÀ
- P.30** ESTETICA CASSETTATA
CAISSONED PATTERN
MODELLO / MODEL ALAGOAS
- P.32** MADEIRA LA PORTA DA GARAGE
ELEGANTE E RAFFINATA
MADEIRA THE GARAGE DOOR
ELEGANT AND REFINED
- P.36** PORTE SEZIONALI SCORRIMENTO LATERALE
SECTIONAL DOORS WITH LATERAL SLIDING
- P.39** PORTA PEDONALE PASSO-UOMO LATERALE
LATERAL PEDESTRIAN DOOR
- P.40** PORTA PEDONALE BREVETTATA
PATENTED WICKET DOOR
- P.42** SEZIONALE PANORAMA SERIE SP
PANORAMA SECTIONAL SP SERIES
- P.48** RIEPILOGO ESTETICHE E COLORI
PATTERNS AND COLOURS SUMMARY
- P.52** ACCESSORI - MOTORIZZAZIONE
ACCESSORIES - MOTORISATION
- P.57** INGOMBRI E TIPI DI INSTALLAZIONE
DIMENSIONS AND METHODS OF INSTALLATION
- P.68** PROCESSI INDUSTRIALI
ALL'AVANGUARDIA
ADVANCED INDUSTRIAL
PROCESSES

PORTE PER GARAGE SEZIONALI SECTIONAL GARAGE DOORS

Il progetto industriale nel settore delle chiusure per garage sezionali per il mercato residenziale è partito nel 2007 con il marchio SEIP, oggi con l'integrazione nella realtà industriale Silvelox Group, anche questa linea di porte è marchiata Silvelox. La forza della sua strategia è da sempre quella di detenere la proprietà formale e intellettuale del know-how in ambito tecnico, di progettazione e di produzione di componenti, accessori e profili; questa differenziazione rispetto ai normali assemblatori, ha garantito all'azienda una crescita costante ed una posizione di rilievo sempre maggiore all'interno del competitivo mercato dei produttori di chiusure per garage. L'alta automatizzazione dei processi e l'industrializzazione del ciclo produttivo, favoriscono elasticità e tempi di consegna ridotti, garantendo in ogni caso l'alto livello qualitativo dei prodotti e del servizio.

Un gamma completa di estetiche e funzionalità per coprire tutte le soluzioni di chiusure sezionali. Un forte orientamento industriale con la copertura di numerosi brevetti che dal 2009 ha reso possibile l'apertura ai mercati internazionali.

The industrial project in the field of closures for sectional garages for the residential market started in 2007 with the SEIP brand, today with the integration into the industrial reality Silvelox Group, this line of doors is also branded Silvelox.

A complete range of aesthetics and functionality to cover all sectional closure solutions. A strong industrial orientation with the coverage of numerous patents that since 2019 has made it possible to open up to international markets.

The strength of its strategy has always been to hold the formal and intellectual ownership of the know-how in the technical, design and production of components, accessories and profiles; this differentiation compared to normal assemblers, has guaranteed the company a constant growth and an increasingly important position within the competitive market of manufacturers of garage closures. A complete range of aesthetics and functionalities to cover all solutions of sectional closures. A strong industrial orientation with the coverage of numerous patents that since 2009 has made it possible to open up to international markets



Serie SR
Estetica Piana
Modello Rondonia
Corten RO CD

Serie SR
Pattern Planar
Model Rondonia
Corten RO CO

LE UNICITÀ E LE INNOVAZIONI DELLE NOSTRE PORTE SEZIONALI PER GARAGE

UNIQUENESS AND INNOVATIONS OF OUR SECTIONAL GARAGE DOORS

**MOTORIDUTTORE
MODELLO "HALO"
CON SISTEMA INTEGRATO
DI ILLUMINAZIONE
INTERNA A LED**



**"HALO" DOOR
OPERATOR COMPLETE WITH INDOOR
LED LIGHTING**

**ISOLAMENTO TERMICO
E RISPARMIO ENERGETICO
CON MATERIALI NON INQUINANTI
ESENTI DA CFC**

**THERMAL INSULATION
AND ENERGY SAVING
WITH NON-POLLUTING MATERIALS
CFC FREE**



DISPOSITIVO ELETTRONICO MT600

MT600 è il dispositivo elettronico che consente l'azionamento di un cancello o una porta da garage, utilizzando uno smartphone.

MT600 ELECTRONIC DEVICE

MT600 is the electronic device that allows the operation of a gate or a garage door, using a smartphone.

APP SILVELOX

App dedicata al cliente finale per l'apertura della porta tramite smartphone.

Module for automation control from smartphone.



Serie SR
Estetica Piana
Modello Rondonia
Ral 7016 RO GP

Serie SR
Pattern Piana
Model Rondonia
Ral 7016 RO GP

MANIGLIA ESTERNA A CONCHIGLIA

La maniglia design by "Silvelox" in alluminio pressofuso verniciata a polveri e disponibile nei colori grey, silver e bronze è inserita al centro della porta a filo dell'anta, è un modello esclusivo e brevettato.

SHELL OUTER HANDLE

The handle designed by "Silvelox" in die-cast aluminum painted and available in grey, silver and bronze is inserted in the center of the door flush with the door, it is an exclusive and patented model.



Grey



Bronze



Silver

Maniglia esclusiva Silvelox con sblocco motore come optional.
Exclusive Silvelox handle with engine release as an option.



FACILITÀ DI MONTAGGIO
EASY ASSEMBLY

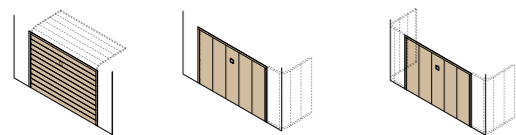

PORTE SEZIONALI RESIDENZIALI PER GARAGE SR-SRV-SLD-SLS

RESIDENTIAL SECTIONAL GARAGE DOORS SR-SRV-SLD-SLS

 **SERIE SR**
SEZIONALE A SCORRIMENTO VERTICALE
CON ALBERO A MOLLE A ROTAZIONE

 **SERIE SR**
VERTICAL SCROLL SECTIONAL
WITH ROTATING SPRING SHAFT

 **SERIE SRV**
SEZIONALE A SCORRIMENTO VERTICALE
CON MOLLE VERTICALI A TRAZIONE

 **SERIE SRV**
VERTICAL SCROLL SECTIONAL
WITH VERTICAL TRACTION SPRINGS

 **SERIE SLD**
SEZIONALE DOPPIO A SCORRIMENTO LATERALE

 **SERIE SLD**
SECTIONAL DOUBLE SIDE SCROLL

 **SERIE SLS**
SEZIONALE SINGOLA A SCORRIMENTO LATERALE

 **SERIE SLS**
SECTIONAL SINGLE SIDE SLIDE

 **SERIE SP**
SEZIONALE PANORAMA AREATA O VETRATA

 **SERIE SP**
PANORAMA SECTIONAL
VENTILATED OR GLAZED

La porta sezionale è composta da pannelli orizzontali, collegati fra loro mediante cerniere e che scorrono verticalmente disponendosi a fine apertura parallelamente al soffitto. Questo particolare meccanismo consente l'utilizzo di tutta la superficie interna del garage.

Le dimensioni massime sono:

SR L = 7,5 m - H = 3,25 m;

SRV L = 4 m - H = 2,5 m;

SLS L = 6 m - H = 3,25 m;

SLD L = 12 m H = 3,25 m.

Sivelox oltre a garantire la sicurezza delle persone, rispettano anche l'ambiente, essendo composte da materiali non inquinanti (esenti da CFC) che permettono l'isolamento termico e favoriscono allo stesso tempo il risparmio energetico.

A sectional door is made of horizontal panels, connected with hinges that slide vertically until they are parallel to the ceiling, once the door is completely open.

This particular system allows the use of the entire internal surface of the garage. Maximum measures are

SR L = 7,5 m - H = 3,25 m;

SRV L = 4 m - H = 2,5 m;

SLS L = 6 m - H = 3,25 m;

SLD L = 12 m H = 3,25 m.

Sivelox are safety for people and environment friendly, since they are made with non-polluting materials which favour both thermal insulation and energy savings at the same time.

Serie SR
Estetica Piana
Modello Rondonia
Ral 9010 RO BI

Serie SR
Pattern Planar
Model Rondonia
Ral 9010 RO BI



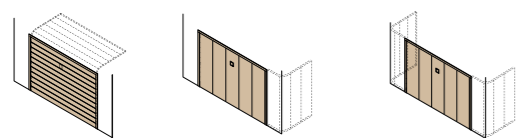

CATEGORIE
ESTETICHE
PANNELLI
PER SERIE
SR-SRV-SLD-SLS

PANELS PATTERNS
CATEGORIES
FOR SERIES
SR-SRV-SLD-SLS

 ESTETICA BIDOGA
DOUBLESLAT PATTERN

 ESTETICA PIANA
PLANAR PATTERN

 ESTETICA MULTIDOGA
MULTISLAT PATTERN

 ESTETICA VENEZIANA
VENETIAN PATTERN

 ESTETICA CASSETTATA
CAISSONED PATTERN

Serie SR
Estetica Piana
Modello Rondonia
Ral 7016 RO GP

Serie SR
Pattern Piana
Model Rondonia
Ral 7016 RO GP



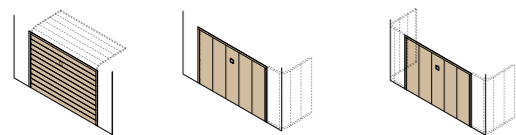

SERIE SR-SRV-SLD-SLS
SR-SRV-SLD-SLS SERIES

ESTETICA BIDOGA DOUBLESLAT PATTERN

Moderna combinazione di linee per un effetto estetico rigoroso ed essenziale. Finiture lisce e goffrate legno a seconda del modello.
Modern combination of lines to create a rigorous and essential effect. Smooth finishes and embossed wood depending on the model.

Pannello coibentato in acciaio zincato spessore 0,5 con verniciatura idonea per una collocazione esterna e atta a garantire la massima durata nel tempo. Pannello brevettato con doga centrale di uguale dimensione alla giuntura dei pannelli per garantire un effetto estetico omogeneo.

Insulated panel made of galvanised steel, 0,5 mm thickness with a special painting suitable for external use and perfect to ensure the best duration in time. A patented panel with a central slat of the same dimension of the junction, to ensure a uniform aesthetic effect.

VISTA ESTERNA
EXTERNAL VIEW

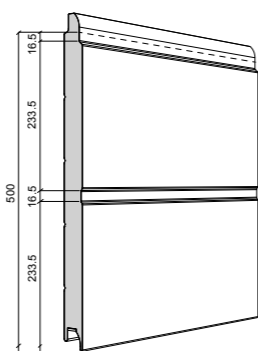

Pannello
H 500

VISTA INTERNA
INTERNAL VIEW

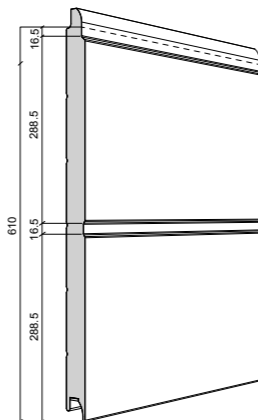
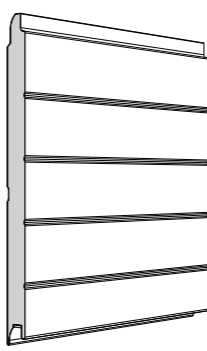

Pannello
H 610

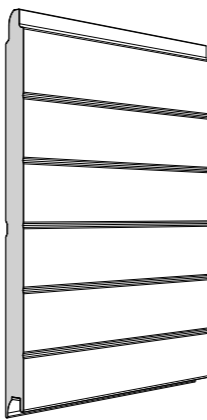

Pannello H 610 disponibile solo per modello Goias GO BI
Panel H 610 available only for Goias GO BI model



Serie SR
Estetica Bidoga
Modello Tocantins
Quercia chiaro TO PL

Serie SR
Pattern Doubleslat
Model Tocantins
Golden oak TO PL

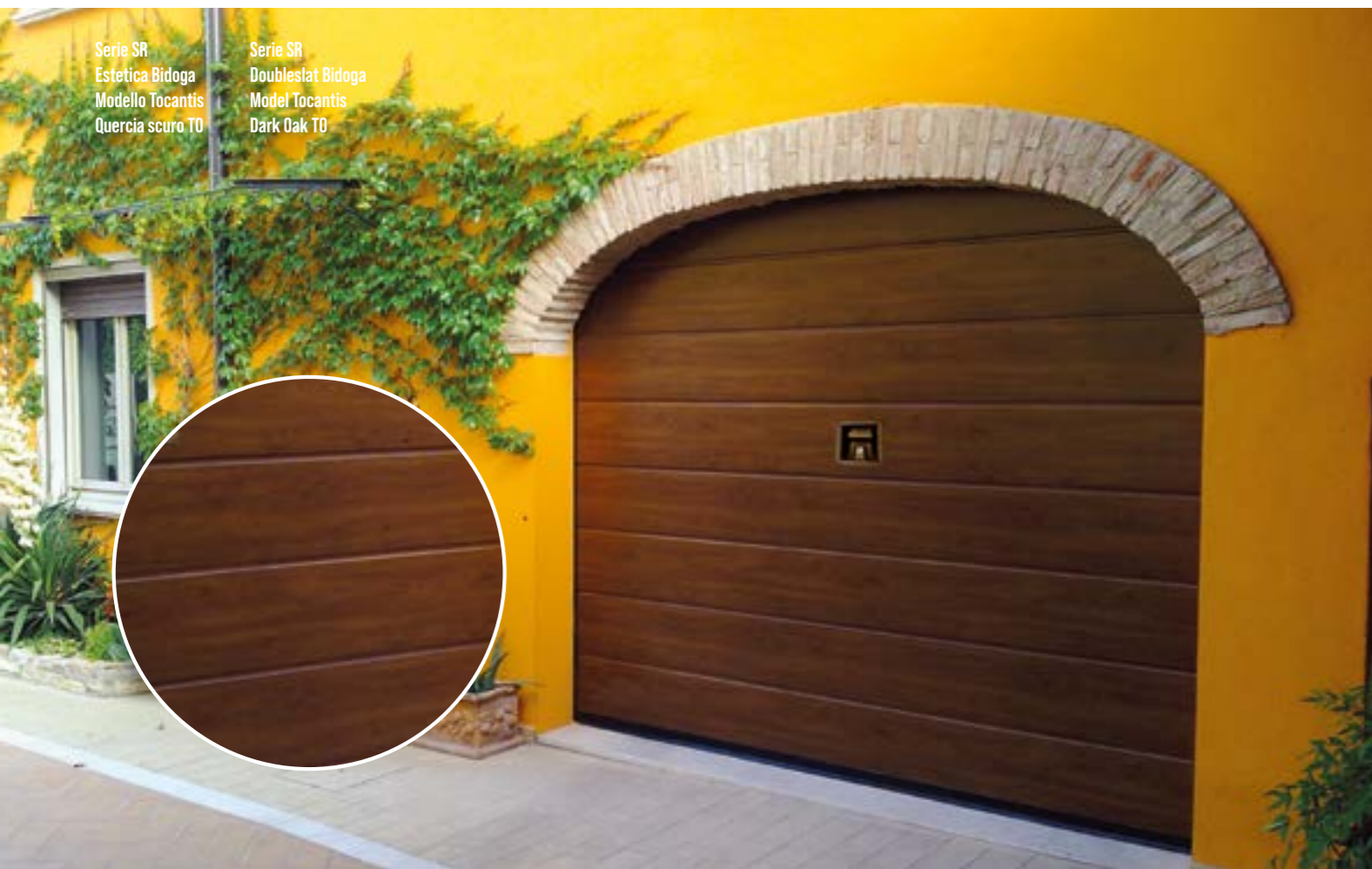

Serie SR
Estetica Bidoga
Modello Tocantins
Quercia scuro TO

Serie SR
Doubleslat Bidoga
Model Tocantins
Dark Oak TO

MODELLO / MODEL TOCANTINS

Questo modello riproduce fedelmente l'effetto del legno con il vantaggio di un'estetica pregiata senza bisogno di manutenzione nel tempo.

This model accurately reproduces the wood effect creating a refined appearance without the need of maintenance.



Finitura interna
Goffrato stucco
Ral 9010

Internal finishing
Embossed succo
Ral 9010

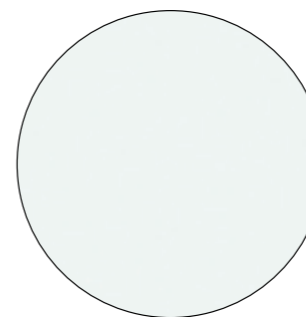

Finitura esterna
Liscio

External finishing
Smooth

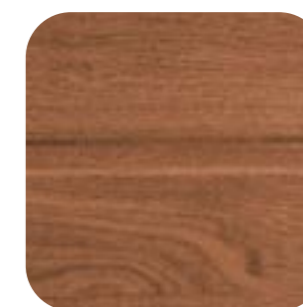

ROVERE MEDIO
MEDIUM OAK



QUERCIA CHIARO
LIGHT OAK



QUERCIA SCURO
DARK OAK



Serie SR
Estetica Bidoga
Modello Goias
Ral 9010 GO BI

Serie SR
Pattern Doubleslat
Model Goias
Ral 9010 GO BI



Serie SR
Estetica Bidoga
Modello San Paolo
Tinte Ral 6028
a richiesta

Serie SR
Pattern Doubleslat
Model San Paolo
Ral 6028 colours
on request

MODELLO / MODEL GOIAS

Stile classico e rigoroso esaltato dalla finitura gofrata e venatura in rialzo ad effetto legnoso.

Traditional and rigorous style enhanced by the embossed finishing and the grains, which create a wooden effect.

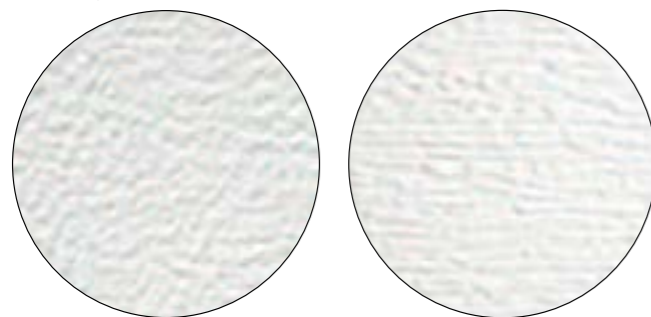

Finitura interna
Goffrato stucco
Ral 9010

Internal embossed
Stucco finish
Ral 9010

Finitura esterna
Goffrato legno

External finishing
Wood grain



RAL 9010

RAL 7035

RAL 7001

RAL 6005

RAL 6009

RAL 8014



TINTE RAL A RICHIESTA
RAL COLOURS ON REQUEST

MODELLO / MODEL SAO PAULO

La perfetta unione tra la moderna eleganza della finitura liscia e la ricercatezza classica della grande scanalatura centrale.

The perfect combination of the modern elegance of the smooth surface and the sophisticated large central.



Finitura interna
Goffrato stucco
Ral 9010

Internal embossed
Stucco finish
Ral 9010

Finitura esterna
Liscio

External finishing
Smooth

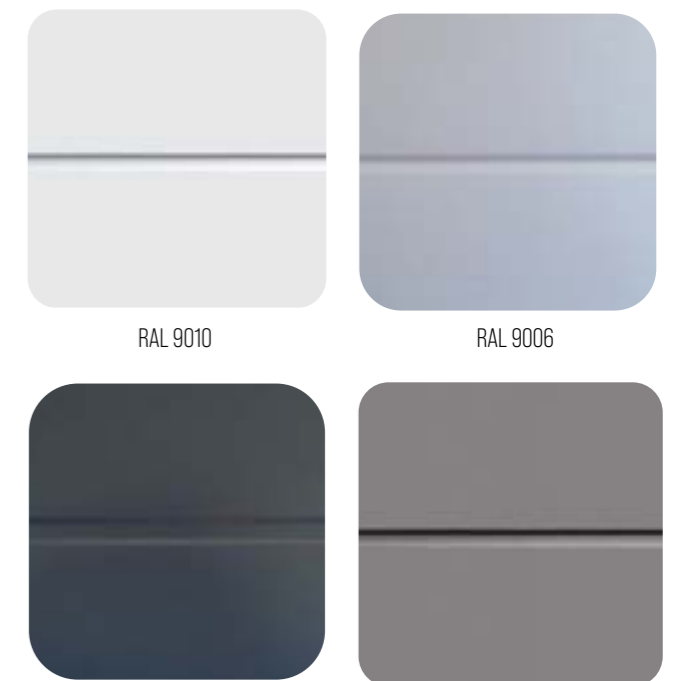

RAL 9010

RAL 9006

RAL 7016
LISCIO E POLYGRAIN

RAL 7001



TINTE RAL A RICHIESTA
RAL COLOURS ON REQUEST

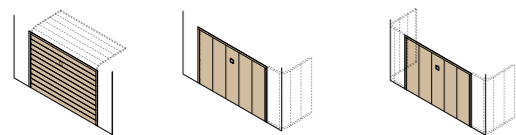

SERIE SR-SRV-SLD-SLS
SR-SRV-SLD-SLS SERIES

ESTETICA PIANA PLANAR PATTERN

L'assenza di doghe e la finitura liscia o gofrata fanno di questa serie la più moderna e tecnologica.

The absence of slats and the smooth or embossed finishing make this model the most modern and technological one.

Pannello coibentato in acciaio zincato spessore 0,6 con verniciatura idonea per una collocazione esterna e atta a garantire la massima durata nel tempo.

Insulated panel made of galvanised steel, 0,6 mm thickness with a special painting suitable for external installation and perfect to ensure the best duration in time.

VISTA ESTERNA
EXTERNAL VIEW

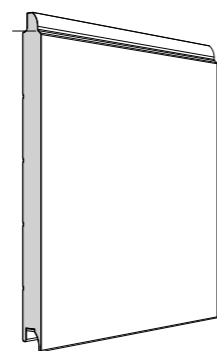

VISTA INTERNA
INTERNAL VIEW

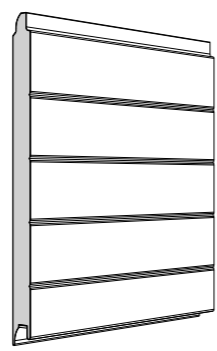

Pannello
H 500

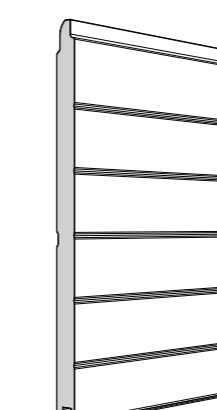
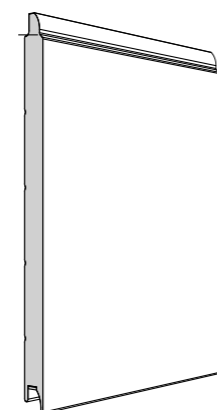

Pannello
H 610

Pannello H 610 disponibile solo per modelli Bahia BA BI e Rondonia GP (Polygrain) RAL 7016
Panel H 610 available only for Bahia BA BI and Rondonia GP (Polygrain) RAL 7016 models



Serie SR
Estetica Piana
Modello Rondonia
Corten RO CO

Serie SR
Pattern Planar
Model Rondonia
Corten RO CO



MODELLO / MODEL RONDONIA

Eleganza e semplicità sulla superficie liscia disponibile in tutta la gamma RAL adatto per l'inserimento in contesti moderni e rigorosi.

Elegance and simplicity on the smooth surface available for the entire RAL series, perfect for modern and rigorous contexts.

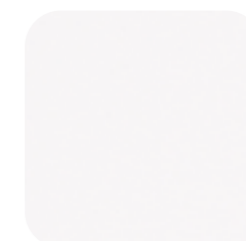

RAL 9010
LISCIO O POLYGRAIN



RAL 7016
POLYGRAIN



RAL 9006



CORTEN



RAL 1013

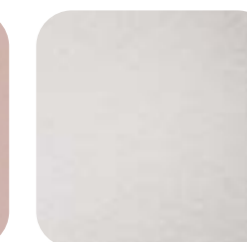

RAL 7035



Finitura interna
Goffrato stucco
Ral 9010

Internal embossed
Stucco finish
Ral 9010

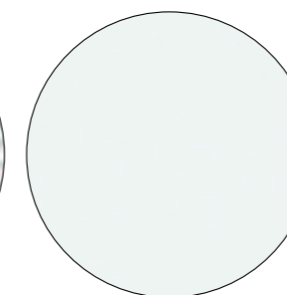

Finitura esterna
Liscio

External finishing
Smooth



TINTE RAL A RICHIESTA
RAL COLOURS
ON REQUEST

Serie SR
Estetica Piana
Modello Rondonia
Ral 9006 RO AR

Serie SR
Pattern Planar
Model Rondonia
Ral 9006 RO AR



Serie SR
Estetica Piana
Modello Bahia
Ral a scelta

Serie SR
Pattern Planar
Model Bahia
Ral colours on request



Serie SR
Estetica Piana
Modello Amazonas
Quercia chiaro AM PL

Serie SR
Pattern Planar
Model Amazonas
Golden Oak AM PL

MODELLO / MODEL BAHIA

L'assenza di doghe unita alla finitura goffrata donano alla porta uno stile semplice e moderno.
The absence of slats combined with the embossed finishing give the door a simple and modern style.



RAL 9010



TINTE RAL A RICHIESTA
RAL COLOURS ON REQUEST



Finitura interna
Goffrato stucco
Ral 9010

Internal finishing
Embossed succo
Ral 9010



Finitura esterna
Goffrato legno

External finishing
Wood grain

MODELLO / MODEL AMAZONAS

La perfetta combinazione tra l'effetto legno e la finitura liscia del pannello creano eleganza e modernità allo stesso tempo.

The perfect combination of the wood effect and the smooth finish of the panel create elegance and modernity at the same time.



QUERCIA CHIARO
LIGHT OAK



QUERCIA SCURO
DARK OAK



Finitura interna
Goffrato stucco
Ral 9010

Internal finishing
Embossed succo
Ral 9010

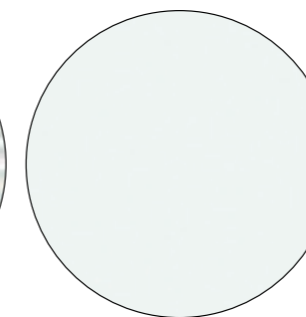

Finitura esterna
Liscio

External finishing
Smooth

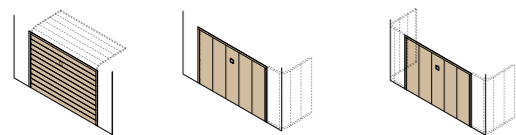

SERIE SR-SRV-SLD-SLS
SR-SRV-SLD-SLS SERIES

ESTETICA MULTIDOGA MULTISLAT PATTERN

Espressione di una sobria eleganza disponibile nella finitura liscia o nella finitura gofrata legno.

It is the expression of sober elegance, available with a smooth finishing or with an embossed wood one.

Pannello coibentato in acciaio zincato spessore 0,5 con verniciatura idonea per una collocazione esterna e atta a garantire la massima durata nel tempo.

Insulated panel made of galvanised steel, 0,5 mm thickness with a special painting suitable for external installation and perfect to ensure the best duration in time.

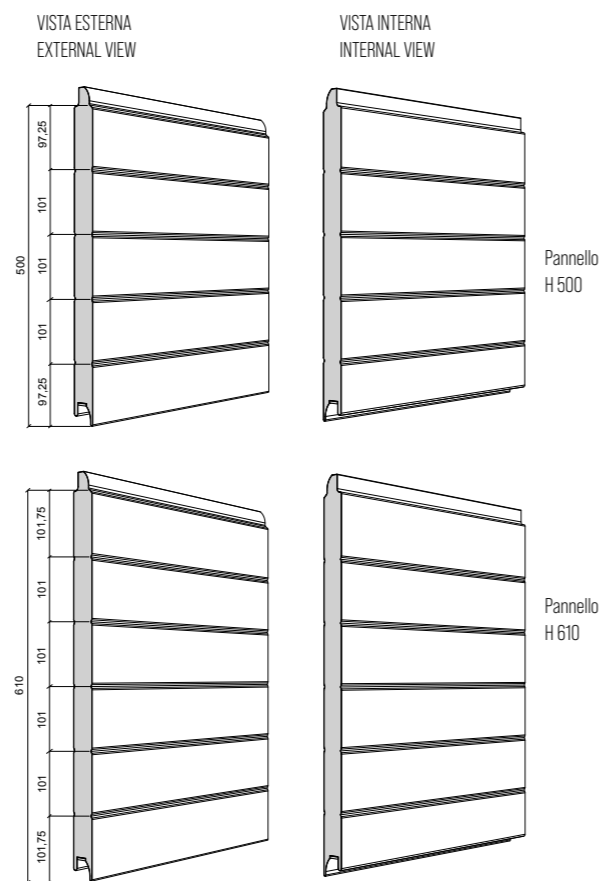

Pannello H 610 disponibile solo per modello Parana PA AR e PA BI
Panel H 610 available only for Parana PA AR e PA BI model



Serie SR
Estetica Multidoga
Modello Sergipe
Quercia chiaro SE PL

Serie SR
Pattern Multislat
Model Sergipe
Light Oak SE PL



Serie SR
Estetica Multidoga
Modello Sergipe
Quercia chiaro SE PL

Serie SR
Pattern Multislat
Model Sergipe
Golden Oak SE PL

MODELLO / MODEL SERGIPE

Il fascino dell'effetto legno sulla superficie liscia a doghe, inalterabile nel tempo.

The elegance of the wood effect on a smooth surface with slats, which cannot be altered in time.



QUERCIA CHIARO
LIGHT OAK



QUERCIA SCURO
DARK OAK



Finitura interna
Goffrato stucco
Ral 9010

Internal finishing
Embossed succo
Ral 9010

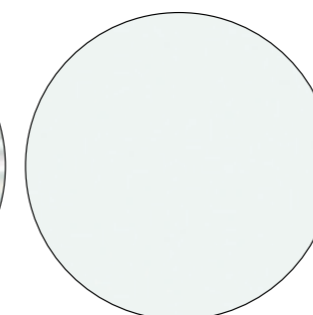

Finitura esterna
Liscio

External finishing
Smooth



Serie SR
Estetica Multidoga
Modello Paraná
Tinte Ral 3003
a richiesta

Serie SR
Pattern Multislat
Model Paraná
Ral 3003 colours
on request



Serie SR
Estetica Multidoga
Modello Amapà
Ral 9006 AP AR

Serie SR
Pattern Multislat
Model Amapà
Ral 9006 AP AR

MODELLO / MODEL PARANA

Finitura gofrata ad effetto legno per un risultato che esprime essenzialità e rigore; disponibile in tutta la gamma RAL.

Embossed finishing with wooden effect for a result which is the expression of minimalism and precision; available in all RAL colours.

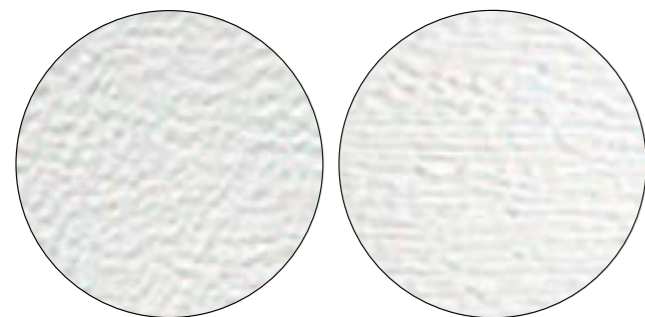

Finitura interna
Goffrato stucco
Ral 9010

Internal finishing
Embossed stucco
Ral 9010

Finitura esterna
Goffrato legno

External finishing
Wood grain



RAL 9010



RAL 9006



RAL 9002



TINTE RAL A RICHIESTA
RAL COLOURS ON REQUEST

MODELLO / MODEL AMAPA

Moderna combinazione di linee che esaltano l'essenzialità di un modello adatto ad inserirsi perfettamente in contesti di diverso stile architettonico.

Modern combination of lines which enhances the minimalism of a model which is perfect for various architectural contexts

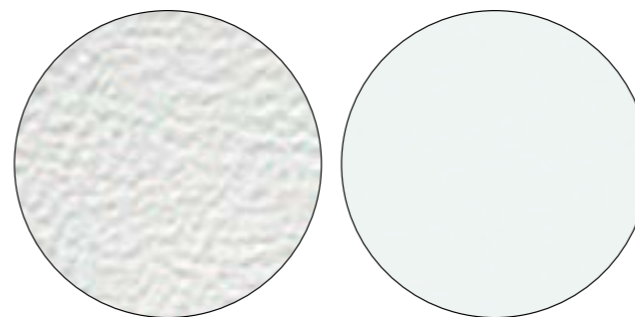

Finitura interna
Goffrato stucco
Ral 9010

Internal finishing
Embossed stucco
Ral 9010

Finitura esterna
Liscio

External finishing
Smooth



RAL 9006



TINTE RAL A RICHIESTA
RAL COLOURS ON REQUEST

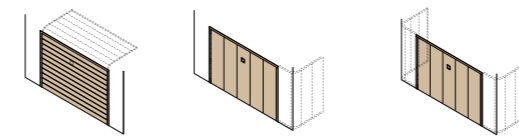

MODELLO / MODEL BRASILIA

Finitura gofrata con venature in rialzo effetto legno. Passo 100 mm e cava 25 mm per 5 mm di profondità.

Embossed finish with raised wood effect grain. 100 mm pitch and 25 mm slot for 5 mm depth.

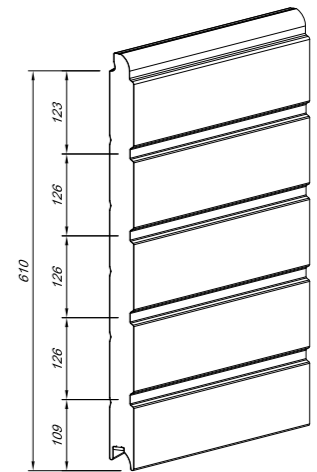

Finitura interna
Goffrato stucco
Ral 9010

Internal finishing
Embossed stucco
Ral 9010

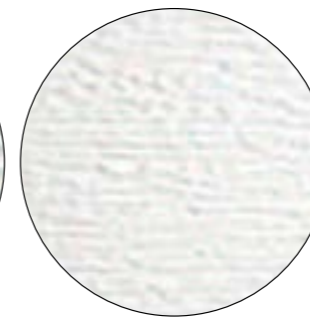

Finitura esterna
Goffrato legno

External finishing
Wood grain



RAL 9016

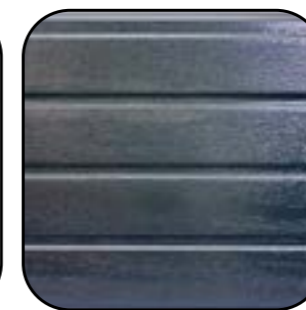

RAL 7016



Pannello
H 610

Serie SR
Estetica Multidoga
Modello Brasilia
Ral 7016
Grigio

Serie SR
Pattern Multislat
Model Brasilia
Ral 7016
Grey

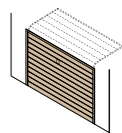

SERIE SR-SRV
SR-SRV SERIES

ESTETICA VENEZIANA VENETIAN PATTERN

Unico ed esclusivo per rendere l'abitazione dove viene inserita la porta di forte personalità.

Unique and exclusive to give a house a strong personality.

Pannello coibentato in acciaio zincato spessore 0,5 con verniciatura idonea per una collocazione esterna e atta a garantire la massima durata nel tempo.

Insulated panel made of galvanised steel, 0,5 mm thickness with a special painting suitable for external installation and perfect to ensure the best duration in time.

VISTA ESTERNA
EXTERNAL VIEW

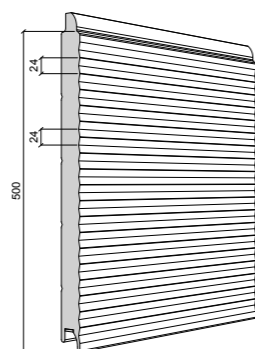

VISTA INTERNA
INTERNAL VIEW

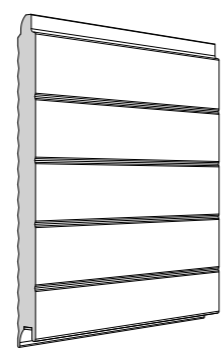

Pannello
H 500



Serie SR
Estetica Veneziana
Modello Parà
Ral 9006 PP AR

Serie SR
Venetian Pattern
Model Parà
Ral 9006 PP AR



Serie SR
Estetica Veneziana
Modello Parà
Ral 9006 PP AR

Serie SR
Venetian Pattern
Model Parà
Ral 9006 PP AR

MODELLQ / MODEL PARÀ

Un pannello brevettato prodotto in esclusiva per SILVELOX che riporta micro doghe orizzontali creando un inconfondibile effetto veneziana.

A patented model exclusively produced for SILVELOX with macro horizontal slats that create an unmistakable venetian blind effect.

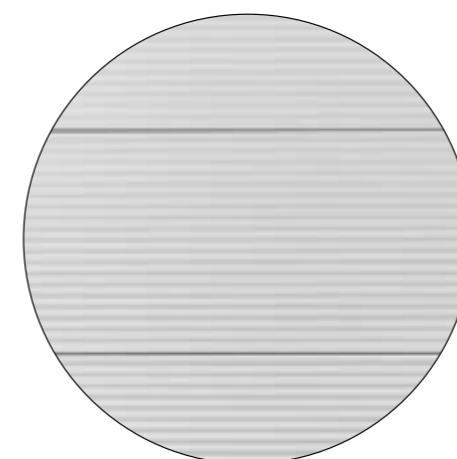

Estetica Veneziana
Venetian Pattern



RAL 9006



TINTE RAL A RICHIESTA
RAL COLOURS ON REQUEST



Finitura interna
Goffrato stucco
Ral 9010

Internal finishing
Embossed succo
Ral 9010

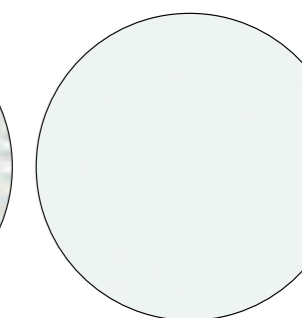

Finitura esterna
Liscio

External finishing
Smooth

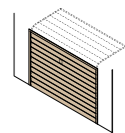

SERIE SR-SRV
SR-SRV SERIES

ESTETICA CASSETTATA CAISSONED PATTERN

Stile tradizionale che riprende la ricerca del particolare e dell'artigianalità tipica del legno.

Traditional style which recalls the research for details and the handmade quality which is typical of wood.

Pannello coibentato in acciaio zincato spessore 0,5 con verniciatura idonea per una collocazione esterna e atta a garantire la massima durata nel tempo.

Insulated panel made of galvanised steel, 0,5 mm thickness with a special painting suitable for external installation and perfect to ensure the best duration in time.

VISTA ESTERNA
EXTERNAL VIEW

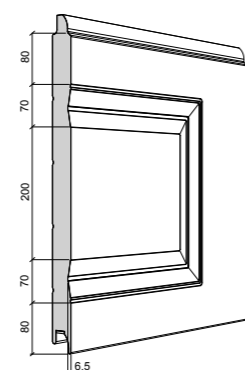

VISTA INTERNA
INTERNAL VIEW

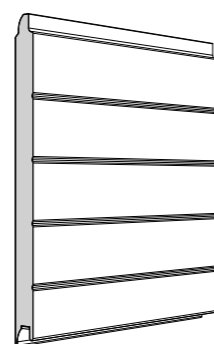

Pannello
H 500

Serie SR	Serie SR
Estetica Cassettata	Caissoned Pattern
Modello Alagoas	Model Alagoas
AL BI	AL BI

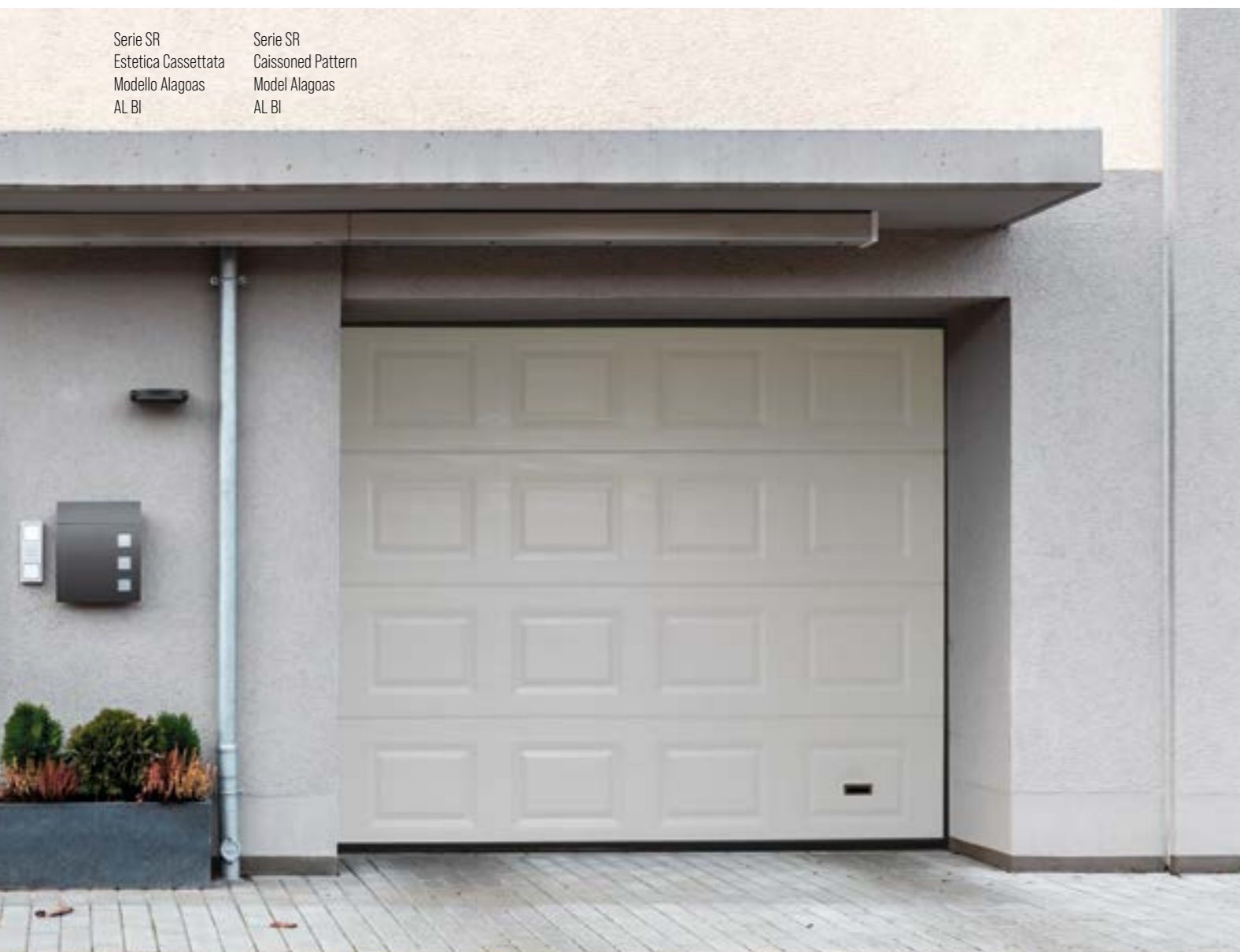

Serie SR
Estetica Cassettata
Modello Alagoas
AL BI

Serie SR
Caissoned Pattern
Model Alagoas
AL BI

MODELLO / MODEL ALAGOAS

Modello di forte personalità grazie alle impronte cassetate che donano alla porta un carattere deciso.
Disponibile nella finitura gofrata legno.

A model with a strong personality obtained thanks to the caissoned design which gives the door grandeur.
Available in wood grain finiture.



RAL 9010



TINTE RAL A RICHIESTA
RAL COLOURS ON REQUEST



Finitura interna
Goffrato stucco
Ral 9010
Internal finishing
Embossed stucco
Ral 9010

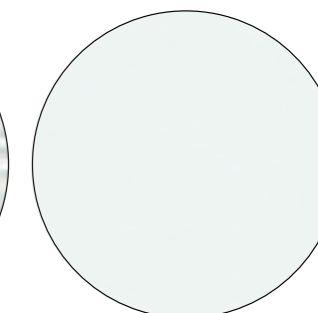

Finitura esterna
Liscio
External finishing
Smooth

MADEIRA LA PORTA DA GARAGE ECOLOGICA IN LEGNO

MADEIRA THE GARAGE DOOR ECOLOGICAL IN WOOD



Serie SR
Estetica cassetata
Modello Alagoas
Okoumé tinta miele

Serie SR
Caissoned pattern
Model Alagoas
Okoumé Honey

Il modello Madeira viene realizzato nella versione sezionale residenziale oppure a scorrimento laterale singolo o doppio. Sono composti da pannelli di spessore 40 mm realizzati in legno marino di okoumé, un pregiato legno idrorepellente e leggero, verniciata all'acqua con vernici ecologiche.

La versione sezionale può essere realizzata fino a larghezze di **4,8 m** ed altezze di **3,1 m**.

La versione porta laterale singola può essere realizzata fino a larghezza di **6 m** ed altezza massima di **3,25 m**.

La versione porta laterale doppia può essere realizzata fino a larghezza di **12 m** ed altezza massima di **3,25 m**.

Essendo un prodotto di design, sono state create diverse eleganti estetiche, ognuna realizzabile in diverse tinte laccate e impregnate.

Per esaltarne il pregio ed elevare la nobiltà del manto, la porta viene fornita con gli accessori del manto di colore nero. Su richiesta, sono disponibili altri optional per impreziosire il prodotto, come oblò realizzati in legno con tamponamento in policarbonato o vetro antisfondamento.

The Madeira model is produced in the residential sectional version or with single or double lateral scrolling. They are composed of 40 mm thick panels made of okoumé marine wood, a precious water-repellent and light wood, water-coated with ecological paints.

The sectional version can be made up to widths of 4.8 m and heights of 3.1 m.

The single side door version can be made up to a width of 6 m and a maximum height of 3.25 m.

The double side door version can be made up to a width of 12 m and a maximum height of 3.25 m.

As a design product, several elegant aesthetics have been created, each of which can be produced in different lacquered and impregnated colours. To enhance its value and raise the nobility of the door, the door is supplied with black door accessories. On request, other optionals are available to embellish the product, such as portholes made of wood with polycarbonate infill or shatterproof glass.



Grey



Bronze



Silver

Maniglia esclusiva Silvelox con sblocco motore come optional.
Exclusive Silvelox handle with engine release as an option.

ESTETICA MADEIRA / PATTERN MADEIRA

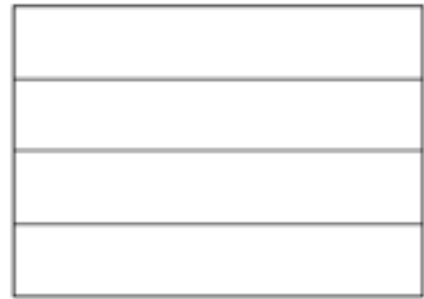

ESTETICA / PATTERN
PIANA 1 - SERIE SR



ESTETICA / PATTERN
PIANA 2 - SERIE SL SLD

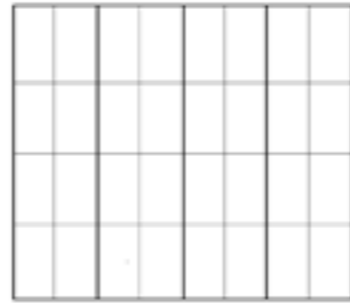

ESTETICA / PATTERN
VIP VERTICALE - SERIE SLS SLD



ESTETICA / PATTERN
BIDOGA 1 - SERIE SR



ESTETICA / PATTERN
BIDOGA 2 - SERIE SLS SLD

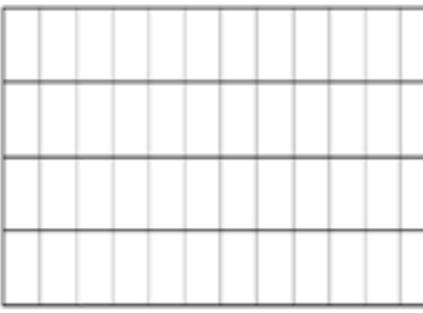

ESTETICA / PATTERN
VIP 1 - SERIE SR

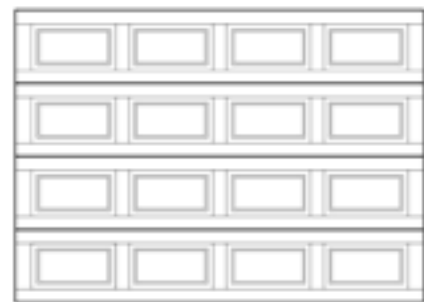

ESTETICA / PATTERN
BIG 1 - SERIE SR

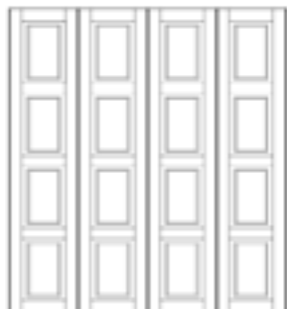

ESTETICA / PATTERN
BIG 2 - SERIE SLS SLD



ESTETICA / PATTERN
SPI - SERIE SR

OBLÒ / WINDOWS

Sono disponibili su richiesta pregiati oblò in legno con tamponamento di 6 mm in policarbonato o vetro antisfondamento. Per altre soluzioni vedi la pagina accessori. High-quality wooden windows with 6 mm polycarbonate or shatterproof glass are available on request. For more solutions see the accessories page.

Accessori di colore nero conferiscono eleganza alla parte interna del manto, rendendolo a tutti gli effetti un elemento di design. Accessories in black colour give elegance to the internal side of the mantle, making it a design element.

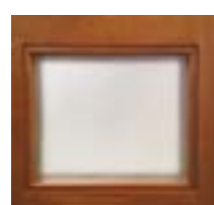
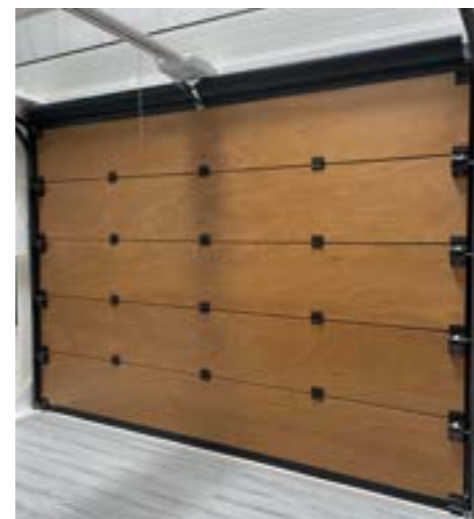

Vista esterna
External View

FINITURE / FINISHES

TINTE DISPONIBILI LEGNO / AVAILABLE WOODEN COLOURS

NATURALI E DA LACCARE O IMPREGNARE NATURAL AND TO BE LACQUERED OR IMPREGNATED

Adatto per esterni / Suitable for outdoors



Okoumé
Okoumé

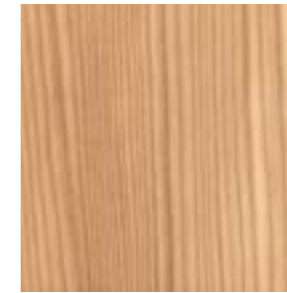

Larice
Larch



Larice Spazzolato
Brushed Larch



Rovere
Oak



Rovere Spazzolato
Brushed Oak

Trasparente per esterni pigmentato bianco - Trasparente per interni 0 gloss / Outdoor clearcoat pigmented white - Indoor clearcoat 0 gloss

DISPONIBILI NELLE FINITURE IMPREGNATE / AVAILABLE IN IMPREGNATED FINISHES

Adatto per esterni / Suitable for outdoors



Tinta Miele
Honey Tint



Tinta Rovere
Oak Tint



Tinta Douglas
Douglas Tint



Tinta Ciliegio
Cherry Tint



Tinta Mogano
Mahogany Tint

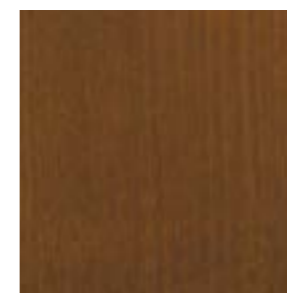

Tinta Noce
Walnut Tint

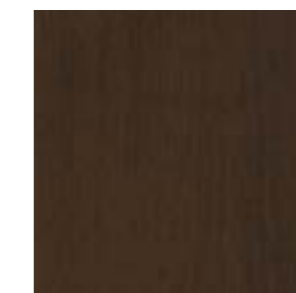

Tinta Noce Scuro
Dark Walnut Tint

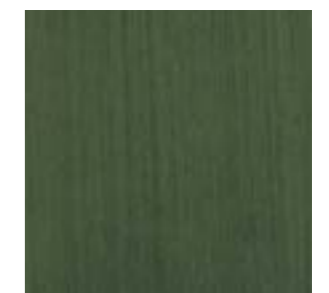

Tinta Verde
Green Tint

Esempio su base Rovere ma disponibile su tutte le essenze. / Example on Oak base but available on all woods.

DISPONIBILI NELLE FINITURE LACCATE / AVAILABLE IN LACQUERED FINISHING

Adatto per esterni // Suitable for outdoors



RAL 1013
Bianco perla / Oyster White



RAL 1019
Beige grigiastro / Greyish beige



RAL 3003
Rosso rubino / Ruby Red



RAL 7001
Grigio argento / Silver Grey



RAL 7006
Grigio beige / Beige Grey

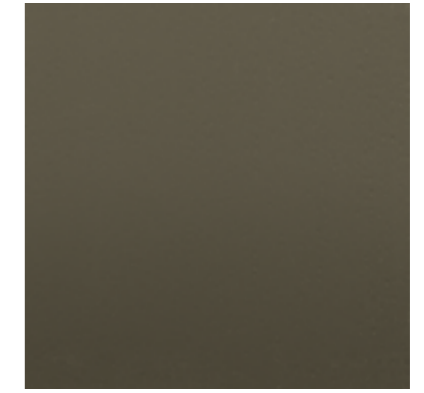

RAL 7013
Grigio brunastro / Brownish grey



RAL 3009
Rosso ossido / Oxide Red



RAL 6005
Verde muschio / Moss Green



RAL 6009
Verde abete / Fir Green

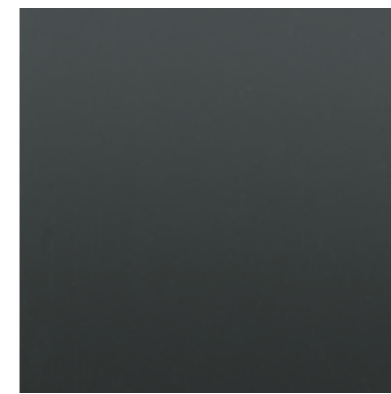

RAL 7016
Grigio antracite / Anthracite Grey



RAL 7030
Grigio pietra / Stone Grey

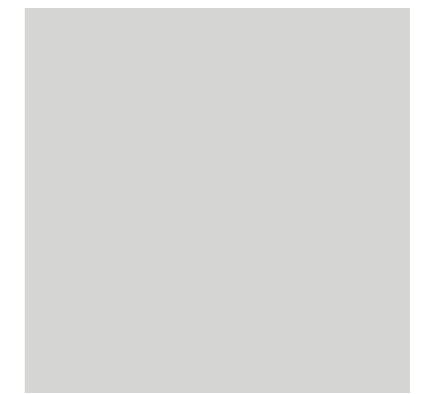

RAL 7035
Grigio luce / Light Grey

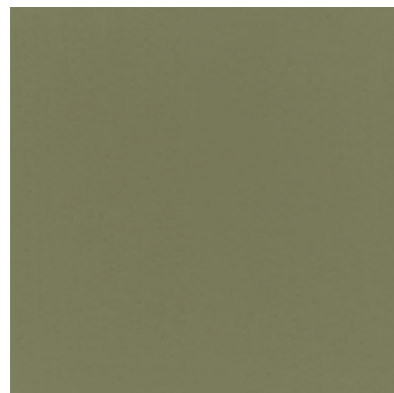

RAL 6013
Verde canna / Reed Green



RAL 6021
Verde pallido / Pale Green



RAL 7000
Grigio vaio / Squirrel Grey



RAL 7036
Grigio platino / Platinum Grey

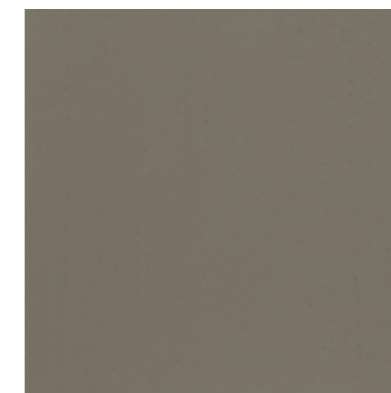

RAL 7039
Grigio quarzo / Quartz Grey



RAL 7040
Grigio finestra / Window Grey



RAL 7044
Grigio seta / Silk Grey



RAL 8017
Marrone cioccolata / Chocolate Brown



RAL 8019
Marrone grigiastro / Grey Brown



RAL 9016
Bianco traffico / Traffic White

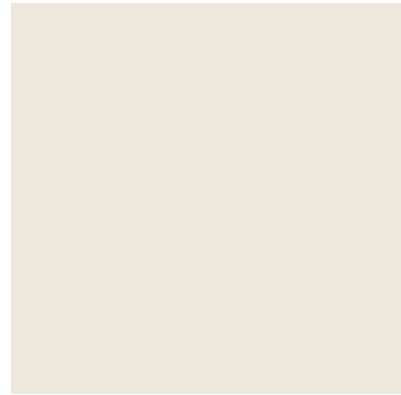

RAL 9001
Bianco Crema / Cream White

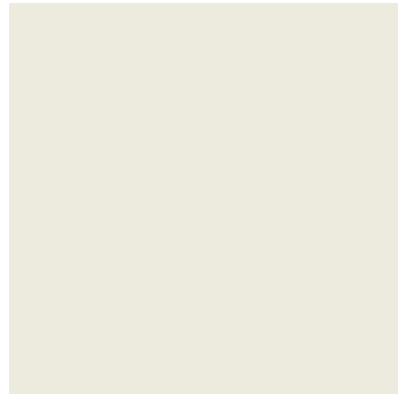

RAL 9002
Bianco grigiastro / Grey White

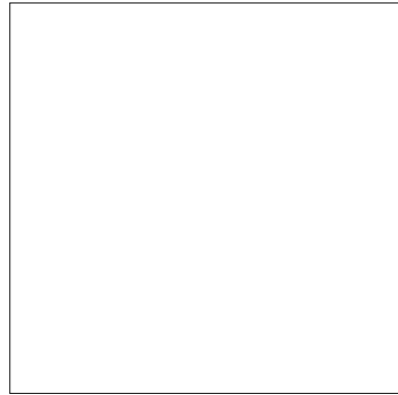

RAL 9003
Bianco segnale / Signal White

DISPONIBILI NELLE FINITURE LACCATE NCS / NCS LACQUERS
Adatto per esterni // Suitable for outdoors



RAL 9005
Nero intenso / Jet Black

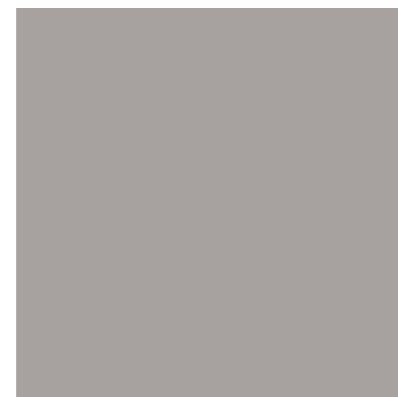

RAL 9006
Alluminio brillante / White Aluminium

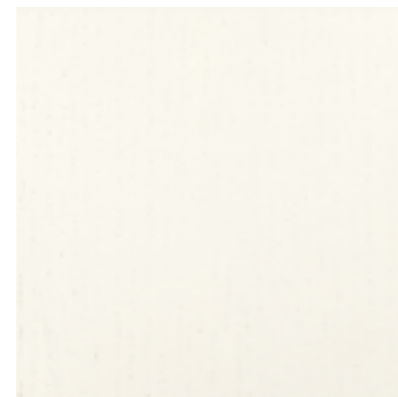

RAL 9010
Bianco puro / Pure White



S 2502-R

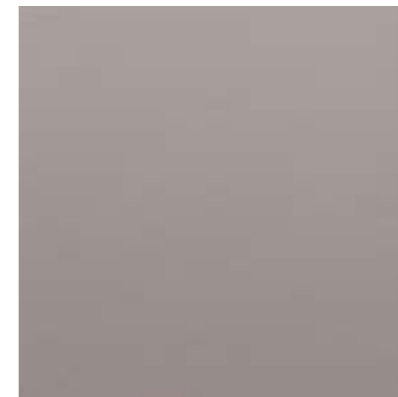

S 4502-R



S 3005-G50Y

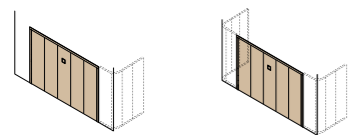

SERIE SLD-SLS
SLD-SLS SERIES

PORTE SEZIONALI SCORRIMENTO LATERALE SECTIONAL DOORS WITH LATERAL SLIDING



ESTETICA BIDOGA
DOUBLESLAT PATTERN

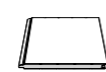

ESTETICA PIANA
PLANAR PATTERN

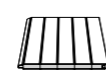

ESTETICA MULTIDOGA
MULTISLAT PATTERN

ANCHE NELLA VERSIONE IN LEGNO VERNICIATA CON VERNICE ECOLOGICA ALL'ACQUA
ALSO IN THE WOODEN VERSION PAINTED WITH ECOLOGICAL WATER-BASED PAINT

SLS e SLD sono le porte ideali in situazioni in cui è necessario eliminare l'ingombro in architrave SLS L = 6 mt e H = 3,25 mt, SLD L = 12 mt e H = 3,25mt .

PANNELLI

Sono disponibili due soluzioni di pannelli:

- Pannello coibentato in acciaio zincato.
- Pannelli spessore 40 mm, realizzate in legno marino di Okoumé nelle finiture tinte legno.

MECCANICA

La parte meccanica di movimentazione prevede lo scorrimento dei pannelli per mezzo di una guida ad architrave senza l'utilizzo di carrelli a pavimento.

La chiusura ermetica della porta è garantita da un mix di guarnizioni in gomma e spazzole su tutto il perimetro.

SLS and SLD are the best doors when it is necessary to reduce the space on the lintel SLS L = 6 mt e H = 3,25 mt, SLD L = 12 mt e H = 3,25mt .

PANELS

Two panel solutions are available:

- Insulated panel in galvanized steel.
- 40 mm thick panels, made of marine wood of Okoumé in wood-colored finishes.

FUNCTIONING

The panels slide thanks to a lintel rail that does not need floor carriages. The hermetic closure of the door is guaranteed by a combination of rubber seals and brushes on the entire perimeter.

Serie SLD
Estetica Multidoga
Modello Tocantis
Pannello in Okoumé
laccato Ral 6005

Serie SLD
Multislat pattern
Model Tocantis
Okoumé panel
lacquered Ral 6005



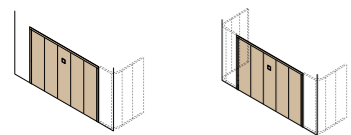

SERIE SLD-SLS
SLD-SLS SERIES

PORTE SEZIONALI SCORRIMENTO LATERALE SECTIONAL DOORS WITH LATERAL SLIDING



Incontro a pavimento: è prevista una soglia ribassata che non ostacola il passaggio.
Floor guide: There is a low threshold which doesn't obstruct the passage.

Nuova ed esclusiva intelaiatura perimetrale in alluminio con spazzolini per una maggiore coibentazione della porta.
New and exclusive perimeter aluminum frame equipped with brushes for a better thermal insulation.



PORTA LATERALE SINGOLA SLS

Larghezza massima realizzabile
L = 6 m ed altezza massima
H = 3,25 m.

LATERAL SINGLE DOOR SLS

Dimensions: maximum width
maximum width W = 6 m maximum
height H = 3.25 m



PORTA LATERALE DOPPIA SLD - Larghezza massima realizzabile L = 12 m ed altezza massima H = 3,25 m.
LATERAL DOUBLE DOOR SLD - Dimensions: maximum width W = 12 m and maximum height H = 3.25 m



SERIE PL
PL SERIES

PORTA PEDONALE PASSO-UOMO LATERALE LATERAL PEDESTRIAN DOOR

PORTA PEDONALE LATERALE

Con telaio in alluminio verniciato, è prevista in dimensioni da 900 a 1200 mm di larghezza e da 2100 a 2500 mm di altezza, con telaio standard di colore nero. Su richiesta è possibile avere dimensioni e colore del telaio speciali. Le porte laterali sono realizzate con i medesimi pannelli delle porte sezionali. Il telaio perimetrale in caso di pannello effetto legno viene sublimato con lo stesso effetto legno. La porta pedonale laterale è disponibile anche sul modello Panorama grigliato, vetrato e due battenti. Sono disponibili accessori come maniglione antipanico, serrature elettriche e sopra-luce vetrati.

LATERAL PEDESTRIAN DOOR

With painted aluminum frame, it is available in different dimensions: from 900 to 1200 mm width and from 2100 to 2500 mm height, with standard black frame. Special dimensions and colours for the frame are available on request. Lateral doors are made with the same panels as sectional doors. The perimeter frame in case of wood effect panel provides with the same wood effect. The side door is also available on the model Panorama gridded, glazed and with double leaf. Accessories such as panic exit bars, electric locks and glazed transoms are available.

Serie SR
Estetica Bidoga
Modello San Paolo
Ral 9006 SP AR

Serie SR
Pattern Doubleslat
Model San Paolo
Ral 9006 SP AR



Esempio di realizzazione porta sezionale con porta laterale, possibilità di utilizzo su tutte le estetiche e modelli [estetica cassettata esclusa]
Example of sectional door with lateral wicket door, available on any pattern and model [caissoned pattern excluded]

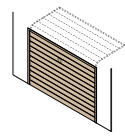

VERSIONI SPECIALI
SPECIAL VERSIONS

PORTA PEDONALE BREVETTATA PATENTED WICKET DOOR



Esempio di realizzazione porta sezionale con porta pedonale inserita, misure disponibili 800 - 900 -1200 mm in larghezza e possibilità di utilizzo su tutte le estetiche e modelli ad esclusione dell'estetica cassetata.

Le caratteristiche che la rendono preziosa:

- Cerniere a scomparsa inserite nei profili di alluminio di disegno Silvelox, silenziose e autolubrificanti
- Profili in alluminio senza rivetti esterni, con finitura che garantisce linearità e pulizia

Esiste la possibilità di adottare serrature a 3 o 5 punti di chiusura.

Example of realization of sectional door with pedestrian door inserted, available sizes W 800 - 900 -1200 mm, can be installed on all the aesthetics and models with the exception of boxed aesthetics. Its main characteristics are:

- the hidden hinges inserted in the aluminum profiles, designed by Silvelox. They are silent and self-lubricating.
- the aluminum profiles without external rivets, with a linear and smooth finishing.

A new alternative closure with 3 or 5 locking points is now available.



PLANARITÀ PERFETTA
PERFECT PLANARITY



Anti schiacciamento
interno ed esterno.
Internal and external finger
protection system.



Disponibile pompa chiudiporta progettata in Germania che permette il blocco della porta aperta tramite una pratica leva.

Available door closer device designed in Germany that allows to block the door open using a practical leverage.



Serie SR
Estetica Bidoga
Modello Tocantis
Rovere sbiancato TO RC

Serie SR
Doubleslat pattern
Model Tocantis
Bleched oak TO RC



SOGLIA RIBASSATA 18 MM COMPRESO GUARNIZIONE
LOWERED THRESHOLD 18 MM INCLUDING GASKET



Montaggio facile grazie alle particolari piastrelle di centraggio che garantiscono il perfetto allineamento dei profili.

Easy to install thanks to particular centering plates that guarantee the perfect alignment of the frames.



Per maggior sicurezza disponibile chiusura a 3 o 5 punti.
If more security is required 3 or 5 lock points latch is available



CHIAVI DI SICUREZZA
SAFETY KEYS



MANIGLIA ERGONOMICA IN ALLUMINIO
ERGONOMIC HANDLE IN ALUMINUM

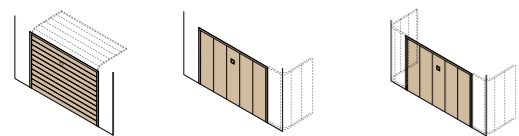

SERIE SP
SP SERIES

SEZIONALE PANORAMA SERIE SP PANORAMA SECTIONAL SP SERIES

Il modello PANORAMA è disponibile nella variante VETRATA: il telaio in alluminio sostiene in questo caso sezioni in metacrilato o vetro, garantendo un elevato livello di luminosità. Si garantisce la possibilità di optare per soluzioni totalmente grigliate o vetrate, oppure un mix tra le due versioni, o ancora un mix tra i pannelli PANORAMA e i normali pannelli coibentati. Disponibile nei vari colori RAL o effetto legno. Le dimensioni massime sono **L = 6 m - H = 3,10 m**.

The Panorama Model is available in the GLAZED version: the aluminum case supports methacrylate or glass sections, ensuring a high quality level of natural light. It is possible to opt for solutions with grids, glass or a combination of the two versions, as well as a combinations of panorama and normal insulated panels. They are available in all RAL colours or wood effect. Maximum measures **W = 6 m - H = 3.10 m**.



Serie SP
Estetica Panorama
Modello grigliato
Ral 6005

Serie SP
Panorama pattern
Model grigliato
Ral 6005

Esempio di realizzazione porta sezionale con inserti in alluminio tamponati con rete stirata. Possibilità di utilizzo su tutte le estetiche e modelli.
Example of a sectional door with aluminum elements that hold a metal glazed net. Available for all models and aesthetics.



Serie SP
Estetica Panorama
Modello Vetrato
Ral 9010

Serie SP
Panorama pattern
Model Glazed
Ral 9010

Qualora si necessiti di un elevato livello di aerazione, si propone il modello PANORAMA GRIGLIATO, dotato di griglie inserite nei telai in alluminio che costituiscono il pannello. Sono disponibili griglie con aerazione vuoto su pieno del 50% oppure dell'81%.

If a high level of air flow is needed, GRILLED PANORAMA is the best solution, being equipped with grids instead of the traditional panels. Grids are available with a 50% or 81% of open area for air passage.

ESEMPI DI PORTE SEZIONALI CON INSERIMENTO DI PANNELLI PANORAMA EXAMPLES OF SECTIONAL DOORS WITH PANORAMA PANELS INSERTIONS

SOLUZIONI DI TAMPONAMENTO DISPONIBILI:

Polycarbonato trattato UV 3 mm trasparente o opale
Polycarbonato trattato UV in camera 3/12/3 opale o trasparente
Polycarbonato alveolare 16 mm
Vetro 3+3 trasparente
Rete con aerazione 67% e 50%
vetro 5+5 stopsol grigio o bronzo
vetro 3+3 satinato bianco

AVAILABLE SOLUTIONS:

3 mm UV treated polycarbonate transparent or opal
UV treated polycarbonate in 3/12/3 opal or transparent
UV treated polycarbonate alveolar chamber or 16 mm
3 + 3 transparent glass
Mesh with ventilation 67% and 50%
5+5 stopsol grey or bronze glass
3+3 frosted white glas

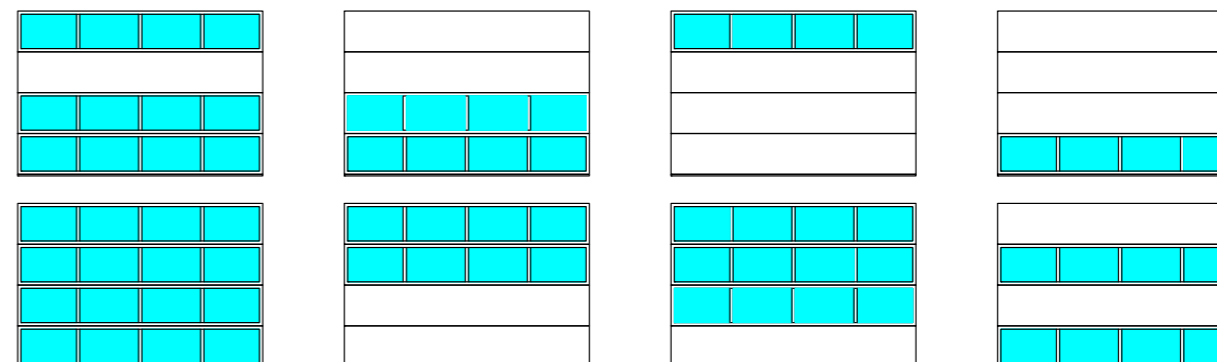

Possibilità di altre configurazioni contattando ufficio tecnico commerciale.
Possibility of further configurations by contacting the technical sales office.

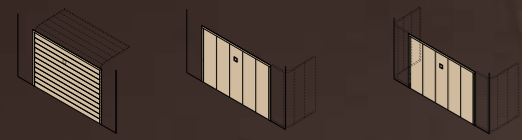

LE UNICITÀ E LE INNOVAZIONI DELLE NOSTRE PORTE SEZIONALI PER GARAGE

UNIQUENESS AND INNOVATIONS OF OUR SECTIONAL GARAGE DOORS

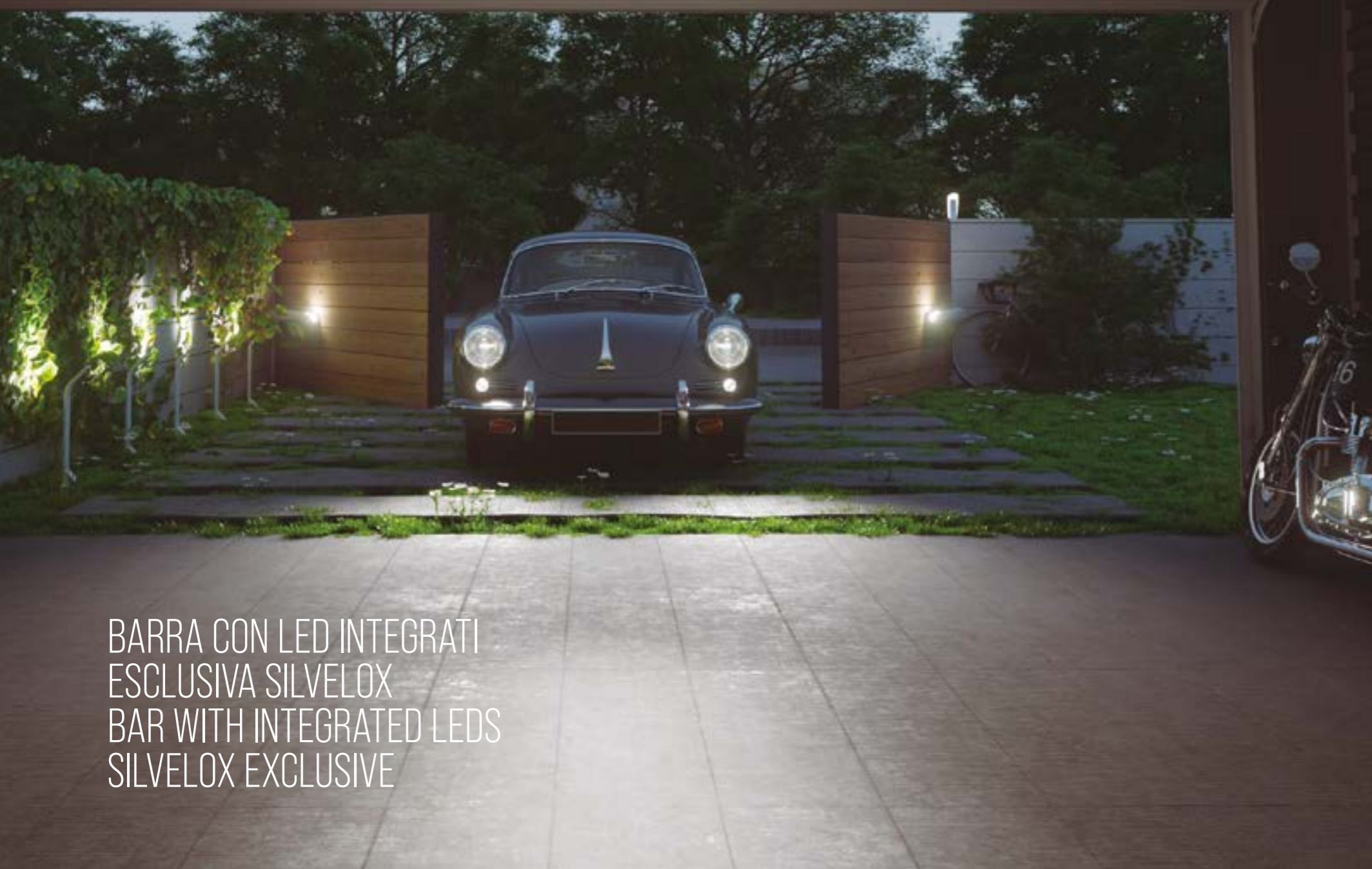

BARRA CON LED INTEGRATI
ESCLUSIVA SILVELOX
BAR WITH INTEGRATED LEDS
SILVELOX EXCLUSIVE



FOTOCELLULA DI SICUREZZA TSD BREVETTATA PATENTED TSD SAFETY PHOTOCELL



L'innovativo sistema di sicurezza, atto ad evitare eventuali urti e/o schiacciamenti da parte di cose o persone durante la movimentazione automatica delle porte sezionali SR.

The innovative security system, designed to avoid any knock and / or crushing by things or people during the automatic movement of sectional SR doors.

DISPOSITIVO ANTICADUTA SAFETY DEVICE



Dispositivo anticaduta in caso di rottura delle funi "a scomparsa" brevettato, con meccanismo incorporato nel pannello.

Patented safety system built inside the panels in case of cable breakage.



MOTORIZZAZIONE MODELLO "HALO" "HALO" MOTORIZATION



Motorizzazione 1000N con guida a cinghia verniciata bianca con illuminazione a led di nostra esclusiva. Disponibile anche con guida a cinghia in acciaio zincato.

1000N motorization with belt guide painted in white complete with our EXCLUSIVE LED lighting. Also available with galvanized steel belt guide.

SEZIONALE SR

CARTER COPRI-MOLLE SPRING COVER

Esclusivo carter copri-molle brevettato che garantisce ottimi risultati estetici.

Patented spring cover that ensures excellent aesthetic and functional results.

Optional disponibile SU RICHIESTA.
Accessory available only on request



RULLO CON PROTEZIONE ANTI SCHIACCIAMENTO ROLLER WITH ANTI-CRUSHING SYSTEM

Protezione innovativa che impedisce il potenziale schiacciamento delle dita.
New safety device that avoids any possible finger injury.



GUIDE DI SCORRIMENTO SLIDING GUIDES

Guide di scorrimento verniciate bianche a polveri.
White powder-painted sliding guides.



CERNIERA LATERALE CON POSIZIONAMENTO RAPIDO SIDE HINGE WITH RAPID POSITIONING

Nuova cerniera laterale brevettata con posizionamento rapido della ruota di scorrimento.

New patented side hinge with rapid positioning of the sliding wheel.



STAFFE FISSAGGIO A SOFFITTO CEILING MOUNTING BRACKETS

L'operazione di montaggio e garantiscono qualità e durata sotto sforzo.
Ceiling mounting brackets, makes easier the mounting operation and guarantees quality and performance during the lift.



SISTEMA DI SCORRIMENTO RIBASSATO LOWERED SLIDING SYSTEM

Sistema di scorrimento brevettato che garantisce apertura e chiusura con rotazione in 150 mm e ingombro in architrave di 150 mm con porte motorizzate totalmente aperte.

Patented sliding system which ensures opening and closing within 150 mm rotation and 150 mm lintel, with motorized doors completely open.



INSERTO ANGOLARE PER DIMA ANGULAR INSERT FOR C-PROFILE

Inserto angolare per il fissaggio a incastro della dima posteriore con le guide orizzontali.

Facile da assemblare garantisce una forte presa.
Angular insert for C-profile. Easy to assemble.
It ensures a firm hold.



ACCESSORI - MOTORIZZAZIONE ACCESSORIES - MOTORISATION

OBLÒ E GRIGLIE DI AERAZIONE PORTHOLES AND AERATION GRIDS



Oblò rettangolare motivo legnoso colore esterno bianco o nero con inglesina dimensioni 322x488 mm interno bianco.
Rectangular porthole. Wood effect finish. Colour: black or white. Dimension 322x488 mm.



Oblò antieffrazione nero. Dimensioni 146x609 mm.
Anti-burglary black porthole. Dimensions 146x609 mm.



Oblò ovale nero interno ed esterno. Dimensioni 660x340 mm.
Oval porthole. Colour: internal and external black. Dimensions: 660x340 mm.

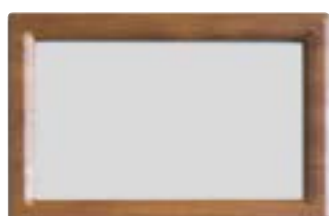

Oblò rettangolare colore esterno simil legno quercia chiaro o quercia scuro, interno bianco. Dimensioni 324x490 mm.
Rectangular porthole. External colour: light or dark oak. Internal colour: white. Dimensions: 324x490 mm.



Oblò rettangolare motivo legnoso colore esterno bianco o nero, interno bianco. Dimensioni 324x490 mm.
Rectangular porthole. Wood effect. External colour: black or white. Internal colour: white. Dimensions: 324x490 mm.

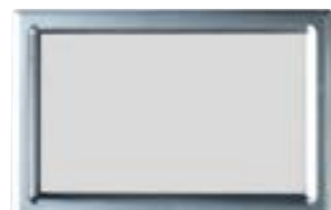

Oblò rettangolare colore esterno cromato, interno bianco. Dimensioni 324x490 mm.
Rectangular porthole. External colour: chrome. Internal colour: white. Dimensions: 324x490 mm.



Oblò rettangolare finitura liscia colore esterno bianco, interno bianco. Dimensioni 364x530 mm.
Rectangular porthole. Smooth finish. External colour: white. Dimensions: 364x530 mm.



Oblò rettangolare finitura liscia colore esterno grigio RAL 7016 interno bianco. Dimensioni 364x530 mm.
Rectangular porthole. Smooth finish. External colour: grey RAL 7016. Internal colour: white. Dimensions: 364x530 mm.



Oblò tondo. Diametro 330 mm.
Round porthole. Diameter 330 mm.



Oblò quadrato cornice esterno ALLUMINIO SPAZZOLATO, interno bianco con vetro opaco di sicurezza 3+3 mm. Dimensioni 290x290 mm.
Square porthole. External colour: BRUSHED ALUMINUM. Internal colour: white. Opaque safety glass 3 + 3 mm. Dimensions: 290x290 mm.



Oblò quadrato colore esterno quercia chiaro, interno bianco con tamponamento esterno trasparente in APET e interno opaco in CIPET dimensioni 290x290 mm o con vetro esterno di sicurezza 3+3 mm. Square porthole. external colour: light oak. Internal colour: white. External finish in APET and opaque internal finish in CIPET. Dimensions 290x290 mm. Security glass 3+3 mm available.



Oblò quadrato colore esterno quercia scuro, interno bianco con tamponamento esterno trasparente in APET e interno opaco in CIPET dimensioni 290x290 mm o con vetro esterno di sicurezza 3+3 mm. Square porthole. external colour: light oak. Internal colour: white. External finish in APET and opaque internal finish in CIPET. Dimensions 290x290 mm. Security glass 3+3 mm available.



Oblò in alluminio anti intrusione alta luminosità
High luminosity anti-intrusion aluminum porthole



Griglia di aerazione bianca o nera. Dimensioni 132x338 mm.
Aeration grid. Colours: black or white. Dimensions: 132x338 mm.



Guide verniciate bianco RAL 9016, da richiedere espressamente in fase d'ordine: migliorano l'aspetto estetico della porta vista internamente.
White RAL 9016 guides, to be required when ordering: improves the internal aesthetic of the door.



Veletta di aereazione grigliata che sostituisce il tubolare in architrave, realizzata in ferro verniciato RAL 9010 o in tinte RAL a richiesta.
Aeration metal grid for replacing the tubular lintel. Colours: painted RAL9010 or other RAL on request.



Maniglia esterna ed interna incassata.
External and internal recessed handle.



Maniglia con pomolo esterno nera per porte manuali o come sblocco motore nel caso di porte motorizzate.
External black handle for manual doors or used as unlocking device for motorized doors.

SISTEMI DI APERTURA E CHIUSURA SMART SMART OPENING AND CLOSING SYSTEMS



Con motore Keyhalo Silvelox e accessorio MT0196 si utilizza APP Silvelox/Key oppure se si vuole collegare l'apertura del cancello elettrico è necessario il dispositivo elettronico MT600 utilizzando uno Smartphone con APP Sildomo

With Keyhalo Silvelox motor and accessory MT0196 you use Silvelox/Key app or if you want to connect the electric gate opener you need the electronic device MT600 using a Smartphone.



APP SILVELOX KEY



APP SILDOMO

MOTORIZZAZIONE MOTORIZATION

Motore elettrico HALO 24Vdc a profilo ribassato, adatto per portoni sezionali fino a 16 m². Dotato di encoder, centrale di comando e ricevitore a 4 canali guida preassemblata a cinghia o catena. Dotato di guida standard zincata o in alternativa, esclusiva guida in alluminio verniciata a polveri con LED integrati, permette l'illuminazione del garage sia durante la movimentazione che in qualsiasi altro momento.

HALO 24Vdc electric motor with low profile, suitable for sectional doors up to 16 m². Equipped with encoder, control unit and 4-channel receiver pre-assembled belt or chain guide. Equipped with standard galvanized guide or alternatively, exclusive powder-coated aluminum guide with integrated LEDs, allows garage lighting both during movement and at any other time.



Selettore HALO con tastierino numerico. Selettore digitale via radio da abbinare a tutti i ricevitori rolling code con batterie incluse.

HALO selector with numeric keypad. Digital radio selector to combine with all rolling code receivers with batteries included.



Apertura e chiusura della porta attraverso il cellulare oppure con radiocomando XR Rolling Code e XR Rolling Code con ricevente e bordo, IP68 resistente all'acqua 4 canali 433 MHz. Semplice, funzionale, ergonomico. Diverse colorazioni intercambiabili.

Opening and closing the door through the mobile phone or with XR Rolling Code radio transmitter with receiver and edge, IP68 water-proof, 4 channels, 433MHz. Easy use, functional, ergonomic. Different interchangeable colors.



1. Centrale domotica di comando miniaturizzata. Programmazione con LED+BUZZER. Memorizzazione di 30 trasmettitori. Spegnimento automatico. Punti di comando luci via cavo.

2. Trasmittitore da incasso 2 canali. Batteria al litio CR2032.
1. Control unit with miniaturized control. Programming with LED + BUZZER. Storage of 30 transmitters. Automatic switch-off. 2. Cable lights control points. 2-channel built-in transmitter. CR2032 lithium battery.



Telecomando touch un canale da incasso sul pannello della porta (fresata da 35 mm). Remote control with touch technology 1 channel for door panel recess.



Lampeggiante Eclipse con antenna integrata. Eclipse flashing with integrated antenna.



Telecomando touch 1 canale da parete. Remote control with touch technology 1 channel for wall.

STRUTTURE PORTANTI IN ALLUMINIO ALUMINUM STRUCTURES

Per garantire un buon impatto estetico ottenendo al tempo stesso maggiore facilità nelle movimentazioni e nelle lavorazioni, si propone tubolari per le spalle laterali e per l'architrave in alluminio con trattamento superficiale innovativo, che dona alla struttura lo stesso grado di finitura del manto.

To ensure a great aesthetic impact, gaining at the same time ease in handling, aluminum tubular products to be fixed on the sides and on the lintel are proposed. Their surface has been treated with an innovative system that gives the structure the same accurate finishing as the sectional door.

Disponibili in tutte le finiture del catalogo pannelli, sia in tinta legno che tinte RAL della porta.
Misure spalla 100x30x2 mm
Misure architrave 150x30x1,5 mm

Available in all colours of the panel catalogue, wood effect or RAL.
Lateral measure 100x3x2 mm
Lintel measure 150x30x1,5 mm

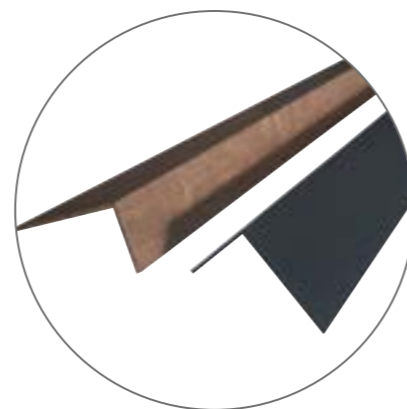

Disponibili coprifili di finitura 50x30 mm in tinta RAL e effetto legno. L-shape profil covers 50x30 mm painted in RAL or wooden effect.



Esempi di realizzazione con struttura in alluminio tinta RAL o effetto legno
Samples of installations with aluminum structure, painted in RAL or wood effect.

INGOMBRI E TIPI DI INSTALLAZIONE DIMENSIONS AND METHODS OF INSTALLATION

SEZIONI VERTICALI SERIE SR
VERTICAL SECTIONS SR SERIES

VERSIONE | VERSION
WA - WM

Scorrimento superiore con architrave 150 mm.
Superior sliding with 150 mm lintel

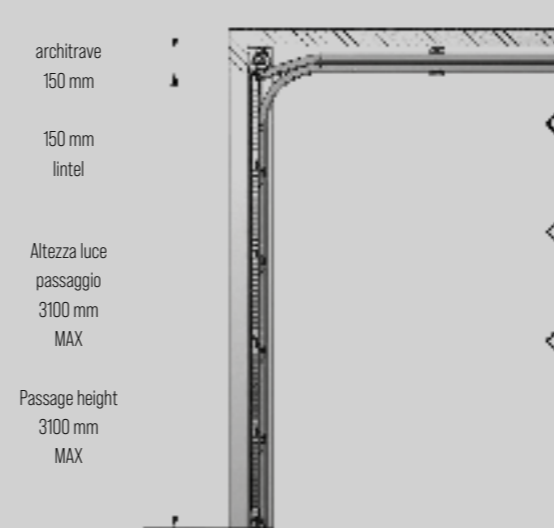

VERSIONE | VERSION
WB

Scorrimento superiore con architrave 250 mm.
Superior sliding with 250 mm lintel

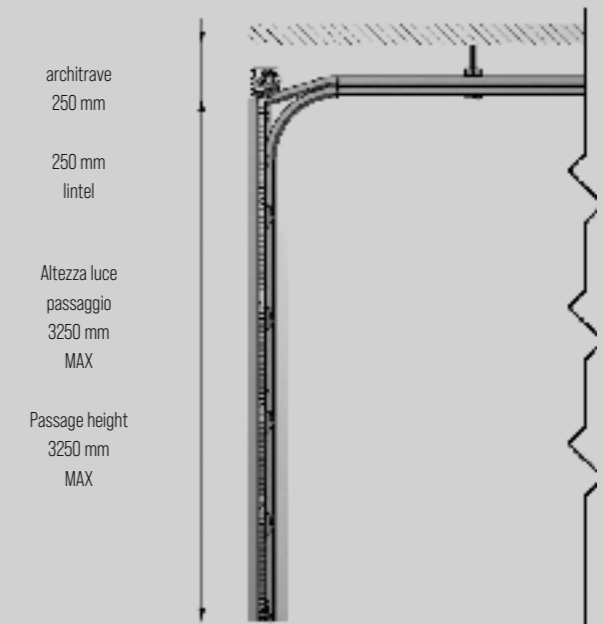

VERSIONE | VERSION
WC - WN

Scorrimento superiore inclinato con architrave 150 mm MAX 12°
Superior sliding with 150 mm lintel max 12°

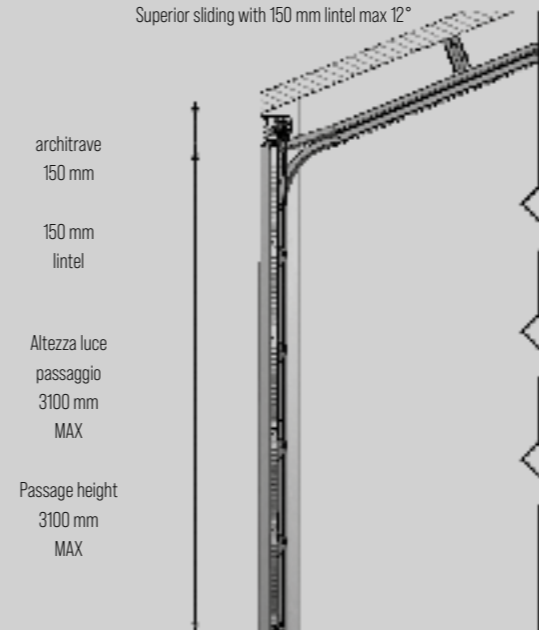

VERSIONE | VERSION
WD

Scorrimento superiore inclinato con architrave 250 mm MAX 22°
Superior sliding with 250 mm lintel MAX 22°

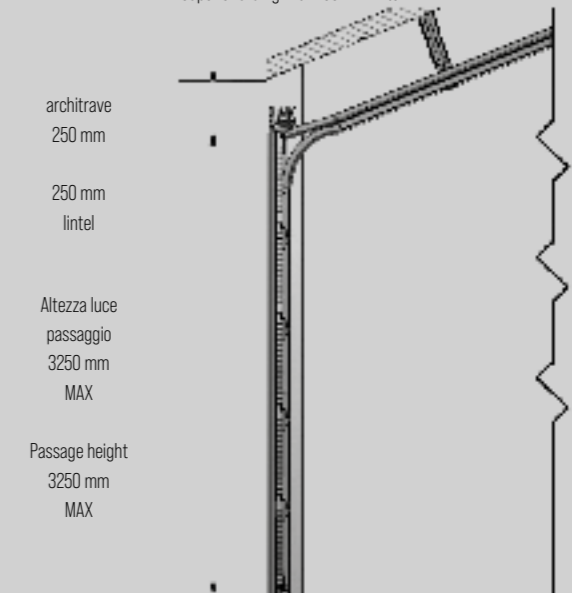

SEZIONI ORIZZONTALI SERIE SR
HORIZONTAL SECTIONS SR SERIES

VERSIONE | VERSION
ST

Portone installabile con battuta destra e sinistra già esistenti. In questo caso non sono necessarie strutture in tubolare extra per il fissaggio.

It can be installed on a structure with already existing left/right jambs. In this case, extra tubular structures to fix are not necessary.



VERSIONE | VERSION
TD

Portone installabile con battuta destra esistente e sinistra mancante. In questo caso è necessaria una struttura in tubolare per il fissaggio.

It can be installed on a structure with only the right jamb. One tubular structure to fix is necessary.



VERSIONE | VERSION
TS

Portone installabile su struttura con battuta destra mancante e sinistra esistente. In questo caso è necessaria una struttura in tubolare per il fissaggio.

It can be installed on a structure with only the left jamb. One tubular structure to fix is necessary.

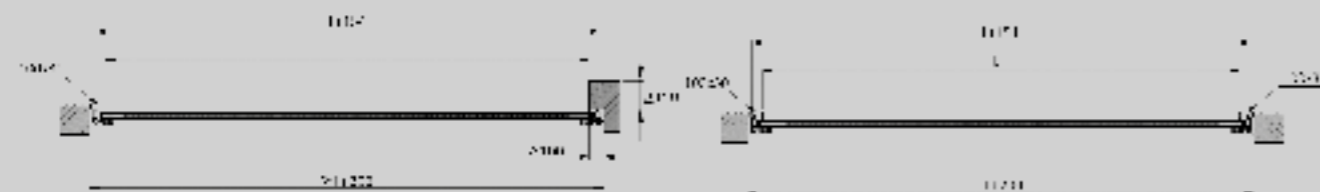

VERSIONE | VERSION
DS

Portone installabile su struttura con battuta destra e sinistra mancante. In questo caso è necessaria una struttura in tubolare per il fissaggio.

It can be installed on a structure without left and right jambs. One tubular structure to fix is necessary.



Sono disponibili tubolari in alluminio in tinte RAL oppure effetto legno da 150x30x2.5 mm e da 100x30x2 mm per realizzare le battute mancanti. Aluminum tubulars to create the missing jambs are available in RAL colours or wood-effect 150x30x2.5 mm or 100x30x2 mm.

SEZIONI VERTICALI E ORIZZONTALI SERIE SRV
HORIZONTAL VIEWS SRV SERIES

VERSIONE | VERSION
WO (SRV)

Scorrimento superiore architrave 100 mm

Superior sliding with 100 mm lintel



VERSIONE ST: Portone installabile su struttura con battuta destra e sinistra già esistenti. In questo caso non sono necessarie strutture in tubolare extra per il fissaggio.

VERSIONE TD: Portone installabile su struttura con battuta destra esistente e sinistra mancante. In questo caso è necessaria una struttura in tubolare per il fissaggio.

VERSIONE TS: Portone installabile su struttura con battuta destra mancante e sinistra esistente. In questo caso è necessaria una struttura in tubolare per il fissaggio.

VERSIONE DS: Portone installabile su struttura con battuta destra e sinistra mancante. In questo caso sono previsti due afferraggi.

ST version: it can be installed on a structure with already existing left/right jambs. In this case, extra tubular structures to fix are not necessary.

TD version: it can be installed on a structure with only the right jamb. One tubular structure to fix is necessary.

TS version: It can be installed on a structure with only the left jamb. One tubular structure to fix is necessary.

DS Version: it can be installed on a structure without left and right jambs. One tubular structure to fix is necessary.

VERSIONE ST
ST VERSION



VERSIONE TD
TD VERSION

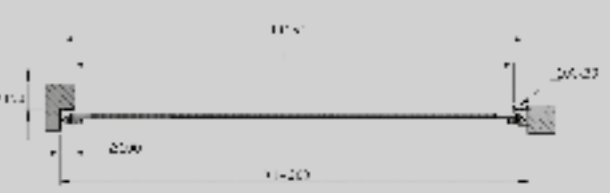

VERSIONE TS
TS VERSION

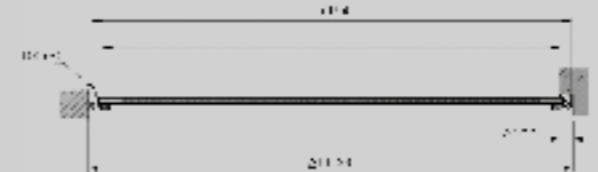

VERSIONE DS
DS VERSION

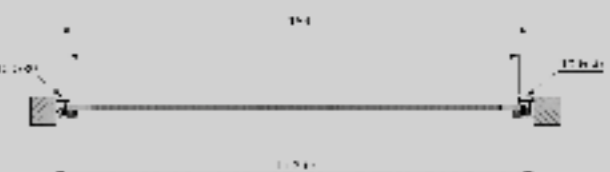

Sono disponibili tubolari in alluminio in tinte RAL oppure effetto legno da 150x30x2.5 mm e da 100x30x2 mm per realizzare le battute mancanti. Aluminum tubulars to create the missing jambs are available in RAL colours or wood-effect 150x30x2.5 mm or 100x30x2 mm.

SEZIONI VERTICALI SERIE SLD-SLS
 SLD-SLS SERIES VERTICAL VIEWS

VERSIONE A
 VERSION A

Non necessita di tubolare per architrave.
 No tubular needed for lintel.

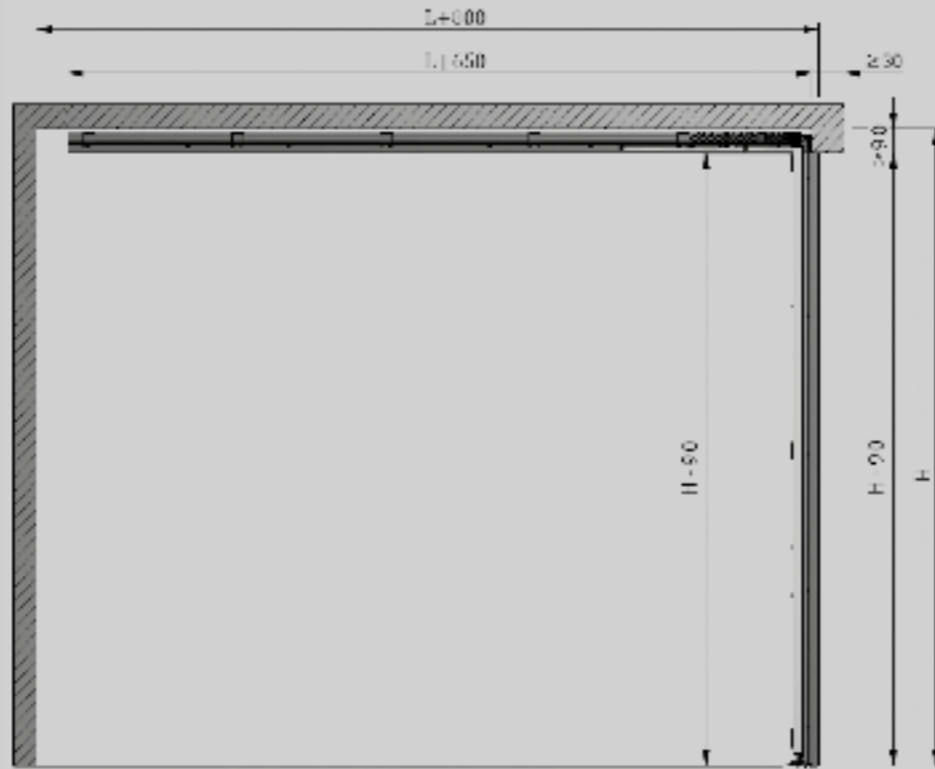

VERSIONE B
 VERSION B

Prevede tubolare per architrave 100x30x2 mm.
 Lintel tubular 100x30x2 mm is required.

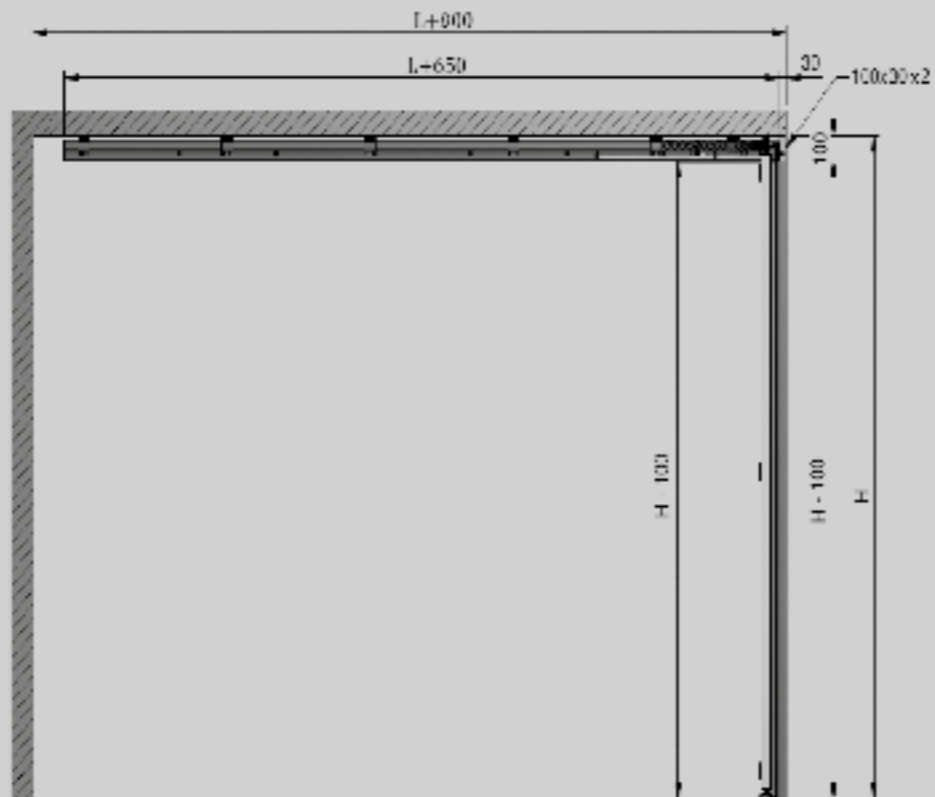

SEZIONI ORIZZONTALI SERIE SLD-SLS
 SLS-SLD SERIES HORIZONTAL VIEWS

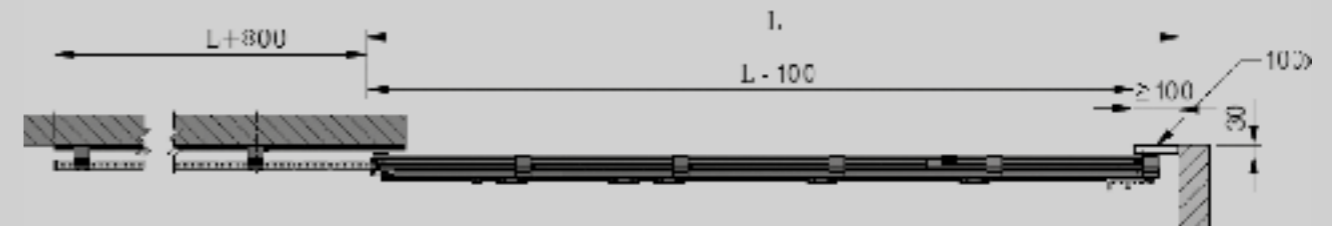
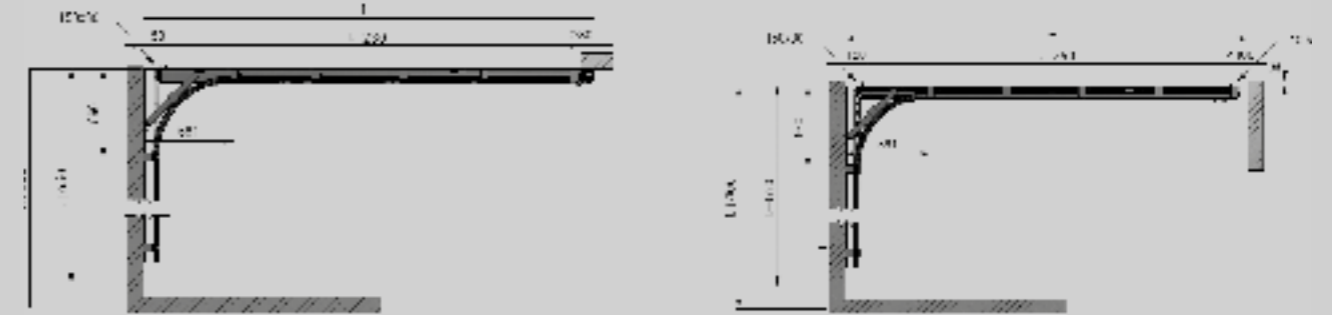
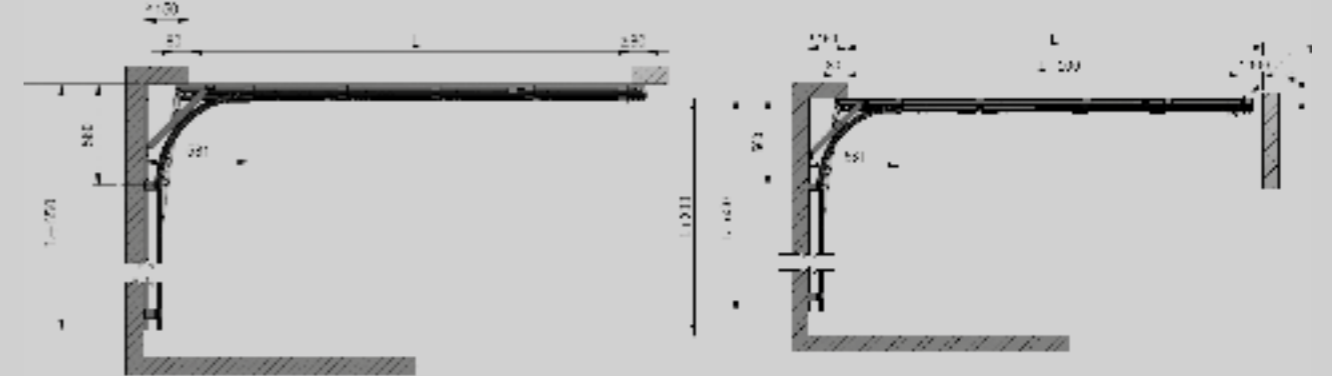

CAPITOLATO PORTE SEZIONALI RESIDENZIALI LATERALI

Pannello coibentato in doppia lamiera

Le porte sezionali residenziali laterali, sono costruite nelle seguenti configurazioni d'apertura:

- SLS_dx_90°
- SLS_sx_90°
- SLS_dx_0°
- SLS_sx_0°
- SLD_dx_90°_sx_90°
- SLD_dx_90°_sx_0°
- SLD_dx_0°_sx_90°
- SLD_dx_0°_sx_0°

ANTA MOBILE COMPOSTA DA PANNELLI COIBENTATI NELLA TIPOLOGIA:

- SAO PAOLO = bidoga – finitura liscia;
- TOCANTINS = bidoga – finitura preverniciato/plasticato finto legno;
- GOIAS = bidoga – finitura goffrato legno;
- AMAPÁ= multidoga – finitura liscia;
- SERGIPE = multidoga – finitura preverniciato/plasticato finto legno;
- PARANÁ = multidoga – finitura goffrato legno
- RONDONIA = piana – finitura liscia;
- AMAZONAS = piana – finitura preverniciato/plasticato finto legno;
- BAHIA = piana – goffrato legno
- PARÀ = veneziana – finitura liscia

di spessore 40 mm, h=500 o 610mm, tipologia antipizzico, realizzati con lamiera in acciaio preverniciato o plasticato, di spessore 0,5 mm e coibentati con poliuretano espanso di densità 35/40 kg/mc, esente da CFC (trasmissione termica dichiarata nella tabella DATI TECNICI);

Profilo cornice pannelli in alluminio verniciato nero opaco ral 9004; profilo telaio perimetrale in alluminio verniciato ral 9004; profilo di battuta in alluminio anodizzato nero; profilo guida inferiore alluminio anodizzato nero; profilo guida superiore in alluminio grezzo; profilo soglia in alluminio nero anodizzato; cerniere intermedie in acciaio di colore bianco; carrelli di scorrimento superiori con vite per regolazione in altezza; curva iniettata grigio ral 7038 in plastica formata da n°2 curve uguali a 45°; braccio multiposizione grezzo sp.6 mm per chiusura ultimo pannello; maniglia in nylon o zama, installati sul pannello in chiusura.

Su richiesta: oblò ovali, rettangolari, quadrati, tondi o griglie di areazione; pannelli in alluminio PANORAMA tamponati con metacrilato singolo o doppio, rete stirata romboidale o quadrata da 2 o 3 mm con areazione 50/81%

Conforme ai requisiti di sicurezza del CPR 305-2011, UNI EN 13241-1 e direttiva macchine 2006/42/CE.
Prestazioni come da tabella DATI TECNICI

Pannello coibentato in legno

Le porte sezionali residenziali laterali, sono costruite nelle seguenti configurazioni d'apertura:

- SLS_dx_90°
- SLS_sx_90°
- SLS_dx_0°
- SLS_sx_0°
- SLD_dx_90°_sx_90°
- SLD_dx_90°_sx_0°
- SLD_dx_0°_sx_90°
- SLD_dx_0°_sx_0°

ANTA MOBILE COMPOSTA DA PANNELLI COIBENTATI NELLA TIPOLOGIA:

- MADEIRA = estetica 1 - piana;
- MADEIRA = estetica 2 - quadra;
- MADEIRA = estetica 3 - multidoga verticale passo 100;

di spessore 40 mm, h=variabile da 400mm a 550mm, in base all'altezza del Manto, tipologia antipizzico, realizzati con legno di Okumè, multistrato di 5 mm e coibentati con nido d'ape continuo tipo KH 30, esente da CFC (trasmissione termica dichiarata nella tabella DATI TECNICI);

Profilo cornice pannelli in alluminio verniciato nero opaco ral 9004; profilo telaio perimetrale in alluminio verniciato ral 9004; profilo di battuta in alluminio anodizzato nero; profilo guida inferiore alluminio anodizzato nero; profilo guida superiore in alluminio grezzo; profilo soglia in alluminio nero anodizzato; cerniere intermedie a scomparsa in PAG di colore nero; carrelli di scorrimento superiori con vite per regolazione in altezza; curva iniettata grigio ral 7038 in plastica formata da n°2 curve uguali a 45°; braccio multiposizione grezzo sp.6 mm per chiusura ultimo pannello; maniglia in nylon o zama installati sul pannello in chiusura.

Su richiesta: oblò quadrati o griglie di areazione.

Conforme ai requisiti di sicurezza del CPR 305-2011, UNI EN 13241-1 e direttiva macchine 2006/42/CE.
Prestazioni come da tabella DATI TECNICI

RESIDENTIAL SECTIONAL LATERAL DOORS SPECIFICATIONS

Insulated panel with double metal sheet

Residential sectional lateral doors are manufactured in the following opening configurations:

- SLS_dx_90°
- SLS_sx_90°
- SLS_dx_0°
- SLS_sx_0°
- SLD_dx_90°_sx_90°
- SLD_dx_90°_sx_0°
- SLD_dx_0°_sx_90°
- SLD_dx_0°_sx_0°

MOVABLE DOOR LEAF CONSISTING OF INSULATED PANELS AS FOLLOWS:

- SAO PAOLO = double-slat - smooth finish;
- TOCANTINS = double-slat - faux wood pre-painted/laminated finish;
- GOIAS = double-slat - embossed wood finish;
- AMAPÁ= multi-slat - smooth finish;
- SERGIPE = multi-slat - faux wood pre-painted/laminated finish;
- PARANÁ = multi-slat - embossed wood finish
- RONDONIA = planar - smooth finish;
- AMAZONAS = planar - faux wood pre-painted/laminated finish;
- BAHIA = flat – embossed wood;
- PARÀ = Venetian – smooth finish;

with thickness of 40 mm, h=500 or 610 mm, anti-pinch type, made of pre-painted or laminated steel sheet, thickness 0.5 mm and insulated with expanded polyurethane with a density of 35/40 kg/m3, free from CFC (thermal conductivity declared in the TECHNICAL DATA);

Aluminum panel frame profile in ral 9004 painted; Aluminum perimetral frame profile in ral 9004 painted; black anodized aluminum jamb profile; black anodized aluminum lower guide profile; upper guide profile in raw aluminum; black painted profile for lowered threshold; concealed intermediate hinges in black PAG; upper sliding trolleys with screw for height adjustment; injected curve ral 7038 grey plastic formed by n°2 curves equal to 45°; multi-position raw arm thick 6 mm for last panel closing; nylon or zama handle, installed on base panel.

On request, oval, rectangular, square and round windows or ventilation grille; aluminum PANORAMA panels partitioned with single or double methacrylate glazing, diamond-shaped or square stretched mesh 2 or 3 mm with 50/81% ventilation.

Complaint with safety requirements of CPR 305-2011, UNI EN 13241-1 and Machine Directive 2006/42/EC.
Performance as indicated in the TECHNICAL DATA table

Wood insulated panel

Residential sectional lateral doors are manufactured in the following opening configurations:

- SLS_dx_90°
- SLS_sx_90°
- SLS_dx_0°
- SLS_sx_0°
- SLD_dx_90°_sx_90°
- SLD_dx_90°_sx_0°
- SLD_dx_0°_sx_90°
- SLD_dx_0°_sx_0°

MOVABLE DOOR LEAF CONSISTING OF INSULATED PANELS AS FOLLOWS:

- MADEIRA = pattern 1 - planar;
- MADEIRA = pattern 2 - square;
- MADEIRA = pattern 3 - vertical multi-slat pitch 100;

with thickness of 40 mm, h=400 or 550 mm, based on the height of the door leaf, anti-pinch type, made of multi-layered 5 mm Okumè wood, insulated with KH 30-type honeycomb material, free from CFC (thermal transfer declared in the TECHNICAL DATA);

Aluminum panel frame profile in ral 9004 painted; Aluminum perimetral frame profile in ral 9004 painted; black anodized aluminum jamb profile; black anodized aluminum lower guide profile; upper guide profile in raw aluminum; black painted profile for lowered threshold; concealed intermediate hinges in black PAG; upper sliding trolleys with screw for height adjustment; injected curve ral 7038 grey plastic formed by n°2 curves equal to 45°; multi-position raw arm thick 6 mm for last panel closing; nylon or zama handle, installed on base panel.

On request, square windows or ventilation grille.

Complaint with safety requirements of CPR 305-2011, UNI EN 13241-1 and Machine Directive 2006/42/EC.
Performance as indicated in the TECHNICAL DATA table

TABELLA DATI TECNICI

	WA	WB	WC	WD	WM	WN	WO
Resistenza al carico del vento EN 12424 · Manto senza porta pedonale inserita, classe (a) · Manto con porta pedonale Standard 800x1867, LP≤ 4000, classe (b) · Manto con porta pedonale Standard 800x1867, LP> 4000 e ≤5000, classe	2	2	2	2	2	2	2
Tenuta all'acqua EN 12425 · Manto senza porta pedonale inserita, classe	30 (70 Pa)	30 (70 Pa)	30 (70 Pa)	30 (70 Pa)	30 (70 Pa)	30 (70 Pa)	30 (70 Pa)
Permeabilità all'aria EN 12426 · Manto senza porta pedonale inserita, classe · Manto con porta pedonale inserita, classe (c)	2 1	2 1	2 1	2 1	2 1	2 1	2 1
Insonorizzazione EN 717-1 · Manto senza porta pedonale inserita R = ... dB (d) · Manto con porta pedonale inserita R = ... dB (d)	22 20	22 20	22 20	22 20	22 20	22 20	22 20
Isolamento Termico EN 13241:2016 Manto coibentato, senza porta pedonale, U = W/ (m²·K) · Manto coibentato con pannello da 40 senza porta (e) Dimensioni LxH 5500x5500 Dimensioni LxH 3500x3500 Dimensioni LxH 3500x2500 · Differenza con Obliò U = W/ (m²·K) (incrementare) · Pannello da 40, U = W/ (m²·K) (f) · Pannello da 50 = W/ (m²·K) (f) · Pannello da 60 = W/ (m²·K) (f) · Pannello da 80 = W/ (m²·K) (f) Manto senza porta pedonale inserita, U = W/ (m²·K) · Vetro metacrilato singolo, U = W/ (m²·K) (g) · Vetro metacrilato doppio U = W/ (m²·K) (h)	1.1 1.3 1.5 +0.1 0.48 0.39 0.33 0.25 5.6 3.4	1.1 1.3 1.5 +0.1 0.48 0.39 0.33 0.25 5.6 3.4	1.1 1.3 1.5 +0.1 0.48 0.39 0.33 0.25 5.6 3.4	1.1 1.3 1.5 +0.1 0.48 0.39 0.33 0.25 5.6 3.4	1.1 1.3 1.5 +0.1 0.48 0.39 0.33 0.25 5.6 3.4	1.1 1.3 1.5 +0.1 0.48 0.39 0.33 0.25 5.6 3.4	1.1 1.3 1.5 +0.1 0.48 0.39 0.33 0.25 5.6 3.4
Struttura Tubolare · Tubolare in alluminio per architrave (mm) · Tubolare in alluminio per spalle (mm)	150x30 100x30	150x30 100x30	150x30 100x30	150x30 100x30	150x30 100x30	150x30 100x30	150x30 100x30
Dimensioni Manto · Larghezza max. mm, L · Altezza max. mm, H	6500 3100	6500 3250	6500 3100	6500 3250	6500 3100	6500 3100	3500 2500
Composizione del manto · Acciaio a doppia parete 40 mm · Acciaio a doppia parete 50 mm · Acciaio a doppia parete 60 mm · Acciaio a doppia parete 80 mm · Alluminio, profilo da 40 mm	▲ ★ ★ \\ ▲	▲ ★ ★ \\ ▲	▲ ★ ★ \\ ▲	▲ ★ ★ \\ ▲	▲ ★ ★ \\ ▲	▲ ★ ★ \\ ▲	▲ ★ ★ \\ ▲
Superficie del manto · Acciaio zincato, pre-verniciato RAL 9010 · Acciaio zincato, pre-verniciato RAL a scelta	▲ ★	▲ ★	▲ ★	▲ ★	▲ ★	▲ ★	▲ ★
Rinforzo manto per resistenza al vento (cl.2) · Pannello da 500/610x40 - Senza omega · Pannello da 500/610x40 - Con 1 omega	<=5000 <=7500	<=5000 <=7500	<=5000 <=7500	<=5000 <=7500	<=5000 <=7500	<=5000 <=7500	<=5000 <=7500
Rinforzo manto per colori scuri (irraggiamento) · Pannello da 500/610x40 - Senza omega · Pannello da 500/610x40 - Con 1 omega	<=5000 <=7500	<=5000 <=7500	<=5000 <=7500	<=5000 <=7500	<=5000 <=7500	<=5000 <=7500	<=5000 <=7500
Sono da evitare i colori scuri nei portoni in acciaio a doppia parete esposti al sole, perché la flessione dei pannelli può compromettere la funzionalità del manto. Silvelox consiglia per questo tipo di porte l'inserimento di un omega aggiuntivo per pannello da 4000 mm (opzionale su richiesta del cliente).							
Porta pedonale inserita · Con soglia ribassata · Con zoccolo standard 130 mm	▲ ▲	▲ ▲	▲ ▲	▲ ▲	▲ ▲	▲ ▲	\\ \\
Porta pedonale laterale	▲	▲	▲	▲	▲	▲	▲
Finestrature							

- Rettangolare 324x490
- Rettangolare 322x488 con inglesina
- Rettangolare 364x530
- Rettangolare antieffrazione 146x609
- Quadrato 290x290
- Ovale 340x660
- Tondo Ø330
- Tondo Ø330 in alluminio spazzolato
- Griglia di areazione 132x338
- Una o più sezioni panorama con vetro singolo o doppio
- Una o più sezioni panorama con rete metallica

▲	▲	▲	▲	▲	▲	▲
▲	▲	▲	▲	▲	▲	▲
▲	▲	▲	▲	▲	▲	▲
▲	▲	▲	▲	▲	▲	▲
▲	▲	▲	▲	▲	▲	▲
▲	▲	▲	▲	▲	▲	▲
▲	▲	▲	▲	▲	▲	▲
★	★	★	★	★	★	★
▲	▲	▲	▲	▲	▲	▲
▲	▲	▲	▲	▲	▲	▲
▲	▲	▲	▲	▲	▲	▲
▲	▲	▲	▲	▲	▲	▲
▲	▲	▲	▲	▲	▲	▲
▲	▲	▲	▲	▲	▲	▲
▲	▲	▲	▲	▲	▲	▲
▲	▲	▲	▲	▲	▲	▲
▲	▲	▲	▲	▲	▲	▲
▲	▲	▲	▲	▲	▲	▲
▲	▲	▲	▲	▲	▲	▲
▲	▲	▲	▲	▲	▲	▲

- Guarnizioni**
- Perimetrale su 4 lati
- Guarnizione intermedia tra gli elementi del Manto

- Sistemi di chiusura**
- Catenaccio con pomello
- Maniglia serratura con pomolo con chiusura laterale

- Sicurezze**
- Protezione salva dita su pannello
- Protezione anti-convogliamento laterale - su ruote
- Sicurezza contro rottura sistema di sospensione
- Sicurezza contro rottura molle

- Possibilità di fissaggio**
- Calcestruzzo
- Acciaio
- Muratura
- Altre possibilità su richiesta

NOTE:

- ▲ = Standard
- ★ = Su richiesta

- (a) Misurata su una porta 6500x3500
(b) Testata anta 3280x2550 (con porta pedonale 800x1800 su 4 pannelli con zoccolo ribassato)
(c) Misurata su una porta 6500x3500
(d) Misurata su una porta 3760x3000
(e) Valore calcolato su una porta coibentata 6500x3500, con pannello da 40, senza porta pedonale
(f) Valore dichiarato dal produttore dei pannelli
(g) Valore calcolato su un Manto completo 6000x5500
(h) Valore calcolato su un Manto completo 4000x3400

TECHNICAL DATA TABLE

	WA	WB	WC	WD	WM	WN	WO
Wind resistance EN 12424							
· Door without pedestrian door, class (a)	2	2	2	2	2	2	2
· Door with Standard pedestrian door 800x1867, LP≤ 4000, class (b)	3	3	3	3	3	3	3
· Door with Standard pedestrian door 800x1867, LP> 4000 e ≤5000, classe	2	2	2	2	2	2	2
Water resistance EN 12425							
· Door without pedestrian door, class	30 (70 Pa)	30 (70 Pa)	30 (70 Pa)	30 (70 Pa)	30 (70 Pa)	30 (70 Pa)	30 (70 Pa)
Air permeability EN 12426							
· Door without pedestrian door, class	2	2	2	2	2	2	2
· Door with pedestrian door, class (c)	1	1	1	1	1	1	1
Insonorization EN 717-1							
· Door without pedestrian door R = ... dB (d)	22	22	22	22	22	22	22
· Door with pedestrian door R = ... dB (d)	20	20	20	20	20	20	20
Thermal insulation EN 13241:2016							
Insulated panel, without pedestrian door, U = W/ (m²·K)							
· Insulated panel 40 mm thick without pedestrian door (e)							
Dimensions WxH 5500x5500	1.1	1.1	1.1	1.1	1.1	1.1	1.1
Dimensions WxH 3500x3500	1.3	1.3	1.3	1.3	1.3	1.3	1.3
Dimensions WxH 3500x2500	1.5	1.5	1.5	1.5	1.5	1.5	1.5
· Difference with a porthole U = W/ (m²·K) (increasing)	+0.1	+0.1	+0.1	+0.1	+0.1	+0.1	+0.1
· Panel 40, U = W/ (m²·K) (f)	0.48	0.48	0.48	0.48	0.48	0.48	0.48
· Panel 50 = W/ (m²·K) (f)	0.39	0.39	0.39	0.39	0.39	0.39	0.39
· Panel 60 = W/ (m²·K) (f)	0.33	0.33	0.33	0.33	0.33	0.33	0.33
· Panel 80 = W/ (m²·K) (f)	0.25	0.25	0.25	0.25	0.25	0.25	0.25
Panel without pedestrian door, U = W/ (m²·K)							
· Single methacrylate panel, U = W/ (m²·K) (g)	5.6	5.6	5.6	5.6	5.6	5.6	5.6
· Double methacrylate panel U = W/ (m²·K) (h)	3.4	3.4	3.4	3.4	3.4	3.4	3.4
Tubular structure							
· Tubolare in alluminio per architrave (mm)	150x30	150x30	150x30	150x30	150x30	150x30	150x30
· Tubolare in alluminio per spalle (mm)	100x30	100x30	100x30	100x30	100x30	100x30	100x30
Panel dimensions							
· Width max. mm, W	6500	6500	6500	6500	6500	6500	3500
· Height max. mm, H	3100	3250	3100	3250	3100	3100	2500
Panel composition							
· Double-walled steel 40 mm	▲	▲	▲	▲	▲	▲	▲
· Double-walled steel 50 mm	★	★	★	★	★	★	★
· Double-walled steel 60 mm	★	★	★	★	★	★	★
· Double-walled steel 80 mm	∥	∥	∥	∥	∥	∥	∥
· Aluminum, profile 40 mm	▲	▲	▲	▲	▲	▲	▲
Panel surface							
· Galvanized steel, pre-painted RAL 9010	▲	▲	▲	▲	▲	▲	▲
· Galvanized steel, pre-painted RAL at choice	★	★	★	★	★	★	★
Panel reinforcing for wind resistance (cl.2)							
· Panel 500/610x40 - Without omega	≤5000	≤5000	≤5000	≤5000	≤5000	≤5000	≤5000
· Panel 500/610x40 - With 1 omega	≤7500	≤7500	≤7500	≤7500	≤7500	≤7500	≤7500
Panel reinforcing for dark colors (irradiation)							
· Panel 500/610x40 - Without omega	≤5000	≤5000	≤5000	≤5000	≤5000	≤5000	≤5000
· Panel 500/610x40 - With 1 omega	≤7500	≤7500	≤7500	≤7500	≤7500	≤7500	≤7500
It is suggested to avoid dark colors when ordering steel panels which will be directly exposed to the sun, as the bending of the panels would compromise the operation of the door. Silvelox suggests in case of order to add 1 omega each panel (optional, on customer request).							
Pedestrian door							
· With lowered threshold	▲	▲	▲	▲	▲	▲	∥
· With standard threshold 130 mm	▲	▲	▲	▲	▲	▲	∥
Lateral pedestrian door	▲	▲	▲	▲	▲	▲	▲

	WA	WB	WC	WD	WM	WN	WO
Windows							
· Rectangular 324x490	▲	▲	▲	▲	▲	▲	▲
· Rectangular 322x488 with Georgian bar	▲	▲	▲	▲	▲	▲	▲
· Rectangular 364x530	▲	▲	▲	▲	▲	▲	▲
· Rectangular anti-intrusion 146x609	▲	▲	▲	▲	▲	▲	▲
· Square 290x290	▲	▲	▲	▲	▲	▲	▲
· Oval 340x660	▲	▲	▲	▲	▲	▲	▲
· Round Ø330	▲	▲	▲	▲	▲	▲	▲
· Round Ø330 in brushed aluminium	★	★	★	★	★	★	★
· Ventilation grille 132x338	▲	▲	▲	▲	▲	▲	▲
· One or more panorama sections with single or double glazing	▲	▲	▲	▲	▲	▲	▲
· One or more panorama sections with metal net	▲	▲	▲	▲	▲	▲	▲
Seals							
· Perimeter seal on 4 sides	▲	▲	▲	▲	▲	▲	▲
· Intermediate seal between the door leaf elements	▲	▲	▲	▲	▲	▲	▲
Closure system							
· Security chain with knob	★	★	★	★	★	★	★
· Handle lock with knob and side closure	★	★	★	★	★	★	★
Safety devices							
· Finger guard on panel	▲	▲	▲	▲	▲	▲	▲
· Side movement prevention - on wheels	▲	▲	▲	▲	▲	▲	▲
· Suspension system safety break device	▲	▲	▲	▲	▲	▲	▲
· Spring break safety device	▲	▲	▲	▲	▲	▲	▲
Anchoring options							
· Concrete	▲	▲	▲	▲	▲	▲	▲
· Steel	▲	▲	▲	▲	▲	▲	▲
· Masonry	▲	▲	▲	▲	▲	▲	▲
· Other options on request	▲	▲	▲	▲	▲	▲	▲

NOTES:

- ▲ = Standard
- ★ = On request

(a) Measured on one door 6500x3500

(b) Door head 3280x2550 (with wicket door 800x1800 on 4 panels with lowered plinth)

(c) Measured on one door 6500x3500

(d) Measured on one door 3760x3000

(e) Value calculated on one insulated door 6500x3500, with panel 40, with no wicket door

(f) Value declared by panel manufacturer

(g) Value calculated on complete door leaf 6000x5500

(h) Value calculated on complete door leaf 4000x3400

PROCESSI INDUSTRIALI ALL'AVANGUARDIA INDUSTRIA 4.0 ADVANCED INDUSTRIAL PROCESSES



Impianto lavorazione pannelli.
Panel processing plant.



Sistema di controllo automatizzato.
Automated control system.



Magazzino pannelli semilavorati.
Semi-finished panels warehouse.



Robot di montaggio strutture metalliche porte sezionali.
Robot for assembling metal structures for sectional doors.



Profilatura lamiera per produzione strutture metalliche per porte.
Profiling department for door metal trackset production.

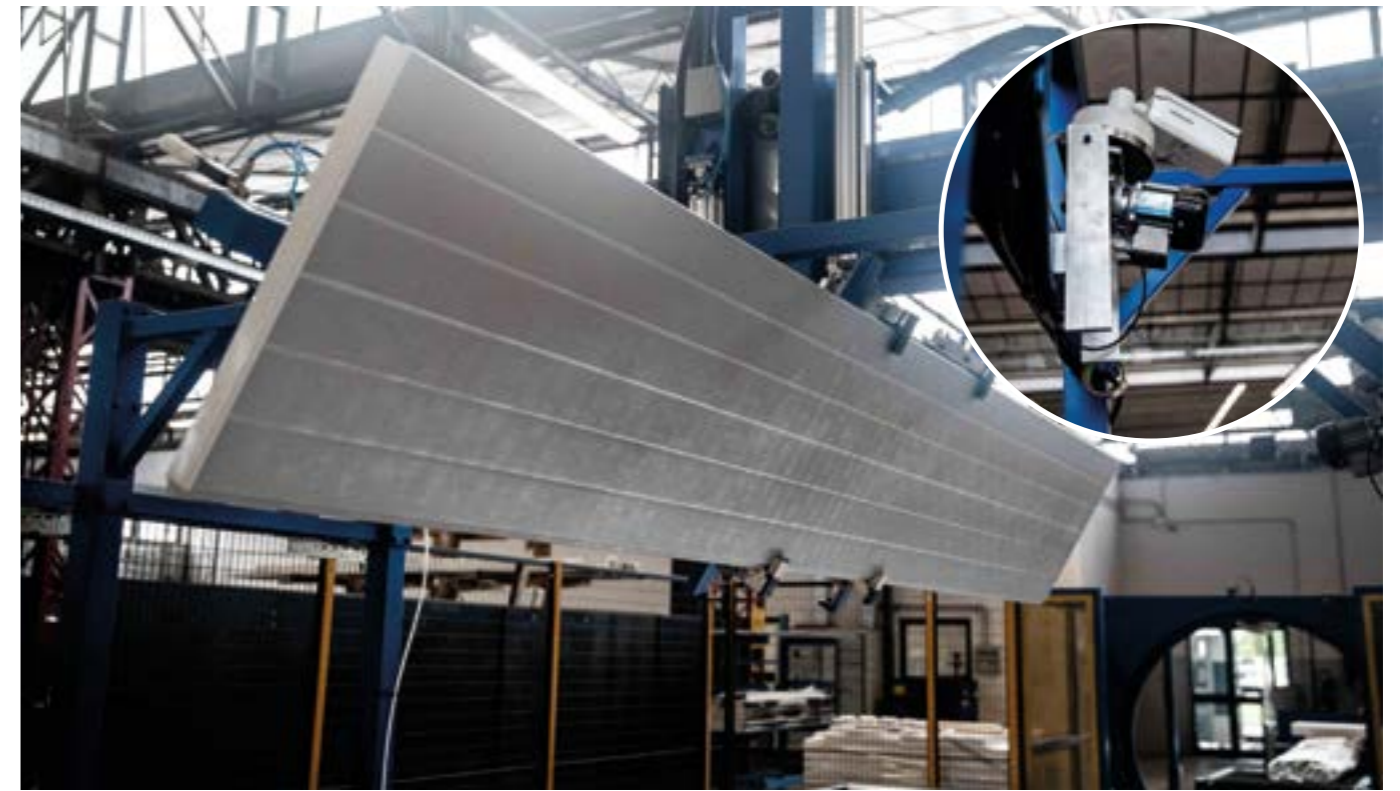

Sistema di controllo automatizzato. Verifica incrociata dell'estetica dei pannelli e sistema di archiviazione di ogni porta.
Automated control system. Cross-checking of panel aesthetics and filing system for each door.



Stazione automatica pannelli semilavorati.
Automatic station for semi-finished panels.



Le condizioni di vendita e certificazioni sono visibili sul sito www.silvelox.it
General sales conditions and certifications available on our website www.silvelox.it



I nostri cataloghi sono stampati
su carta ecologica certificata FSC
Our catalogs are printed
on FSC certified ecological paper

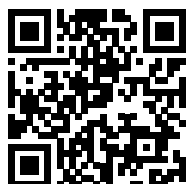

SILVELOX
GROUP SPA

SILVELOX GROUP SPA
www.silvelox.it

P.IVA 02381120225

Headquarters and Production plant:
Viale Venezia, 37 I-38050 Castelnuovo - Trento - Italy
Tel. (+39) 0461 755 755 - Fax (+39) 0461 752 466
info@silvelox.it - silvelox@cgn.legalmail.it - www.silvelox.it

Production plant:
Via Rossi, 14 I-25010 Remedello - Brescia - Italy
Tel. (+39) 030 258 5500 - Fax (+39) 030 258 2537



SILVELOX GROUP S.p.A. nell'intento di migliorare la qualità delle proprie porte, si riserva il diritto di apportare in qualsiasi momento modifiche al prodotto, a tutela della soddisfazione dei propri clienti.
SILVELOX GROUP S.p.A. reserves the right to modify its products at any time to improve the quality of said products and better satisfy customers.